

# PPCH<sub>TEX</sub>

a macropackage  
for typesetting  
chemical structure-  
formulas with T<sub>E</sub>X

J. Hagen & A.F. Otten  
Pragma, Hasselt (NL)  
May 1998

# Contents

## Part 1: Explanation

- 1 Structures 1-3
- 2 Bonds 1-6
- 3 Frontviews 1-12
- 4 Definitions 1-13
- 5 Combinations 1-16
- 6 Text in structures 1-24
- 7 Axis 1-28
- 8 Set ups 1-30
- 9 Symbols 1-33
- 10 Positioning 1-35
- 11 Reactions 1-41
- 12 Subscripts 1-44

## Part 2: Backgrounds

- 1 Installation 2-2
- 2 Extensions 2-3
- 3 Fonts 2-4
- 4 Definitions 2-5
- 5 Color 2-6
- 6 Interaction 2-7

## Part 3: Overview

- 1 One 3-2
- 2 Three 3-4
- 3 Four 3-7
- 4 Five 3-11
- 5 Six 3-16
- 6 Eight 3-22
- 7 Five Front 3-23
- 8 Six Front 3-24
- 9 Carbon 3-25
- 10 Newman Stagger 3-27
- 11 Newman Eclipse 3-28
- 12 Symbol 3-29

# Part 1 Explanation

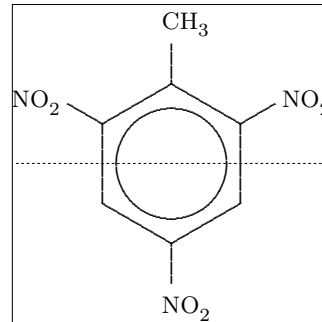

# Introduction

PPCH<sub>TEX</sub> is a set of coherent macros that can be used to typeset chemical structure formulas. The macros fall back on P<sub>1</sub>CT<sub>E</sub>X, a public domain drawing package written by Michael Wichura. Although originally written on top of P<sub>1</sub>CT<sub>E</sub>X, the second release can cooperate with PSTricks of Timothy Van Zandt, that is, with some limitations. Personally we still prefer the quality of the P<sub>1</sub>CT<sub>E</sub>X output.

The macros can be used from within several macro packages and fall back on a few generic CON<sub>T</sub>E<sub>X</sub>T modules. The macros are written in a way that permits relatively easy upward compatible extensions. The interface is conform the CON<sub>T</sub>E<sub>X</sub>T interface.

PPCH<sub>TEX</sub> was originally meant for typesetting chemical structure formulas like sixrings. At the moment there is also support for reaction mechanisms. Formulas can be typeset at different sizes. Common elements or frequently used formula components can be reused.

Flexibility, simplicity and quality have been preferred over speed. We don't use the P<sub>1</sub>CT<sub>E</sub>X option to save pictures, because timing showed that the gain was minimal.

The first version of PPCH<sub>TEX</sub> was ready for use in 1995. This manual describes the second major release. Thanks to the many suggestions of Tobias Burnus, Dirk Kuypers and Ton Otten, the functionality was extended considerably.

*The source of PPCH<sub>TEX</sub> is at this moment no example of a well typeset source. In due time the macros will be optimized and documented.*

Hans Hagen

pragma@pi.net

# 1 | Structures

The number of commands that is used to typeset chemical structure formulas is, apart from some bell and whistle commands, limited to four.<sup>1</sup> In the following example all of these commands are used.

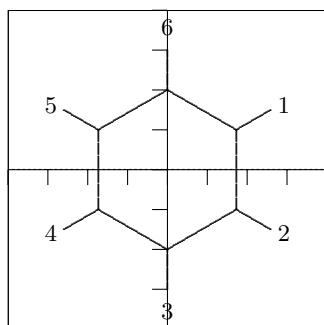

Example 1.1

```
\setupchemical[axis=on,frame=on]
\startchemical
\chemical[SIX,B,R,RZ][1,2,3,4,5,6]
\stopchemical
```

With `\setupchemical` we can influence the makeup of the formulas. These setups influence all the following formulas, unless they are superceded by local setup variables.<sup>2</sup>

The set up variables can be defined right after `\startchemical`. In that case the set up is only applied to one structure formula.

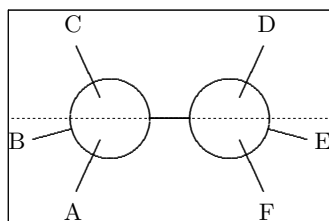

Example 1.2

```
\startchemical[frame=on,width=fit,height=fit]
\chemical[CARBON,CB1][A,B,C,D,E,F]
\stopchemical
```

Both examples show that `\chemical` is the essential command. This command that may be used more than once within a `\start–\stop`-pair, is accompanied with two arguments. These arguments are written between `[ ]`. The first argument is used for defining the chemical bonds, the second argument for the atoms and molecules that make up the structure.

Text is typeset in mathematical mode, this means that you may type anything that normally is allowed between `$ $`.

<sup>1</sup>The concept structure in this manual only refers to the chemical structure. It is not related to the document structure.

<sup>2</sup>One can of course limit the scope of the variables by using `{ }` and/or the grouping macros `..group`.

We will explain the first example in more detail. The key **SIX** means that we want to draw a sixring. In analogy we could type **ONE**, **THREE**, **FOUR** and **FIVE**, **EIGHT**, **CARBON**, **NEWMAN**, **CHAIR**, some alternatives on these keys and some symbols.

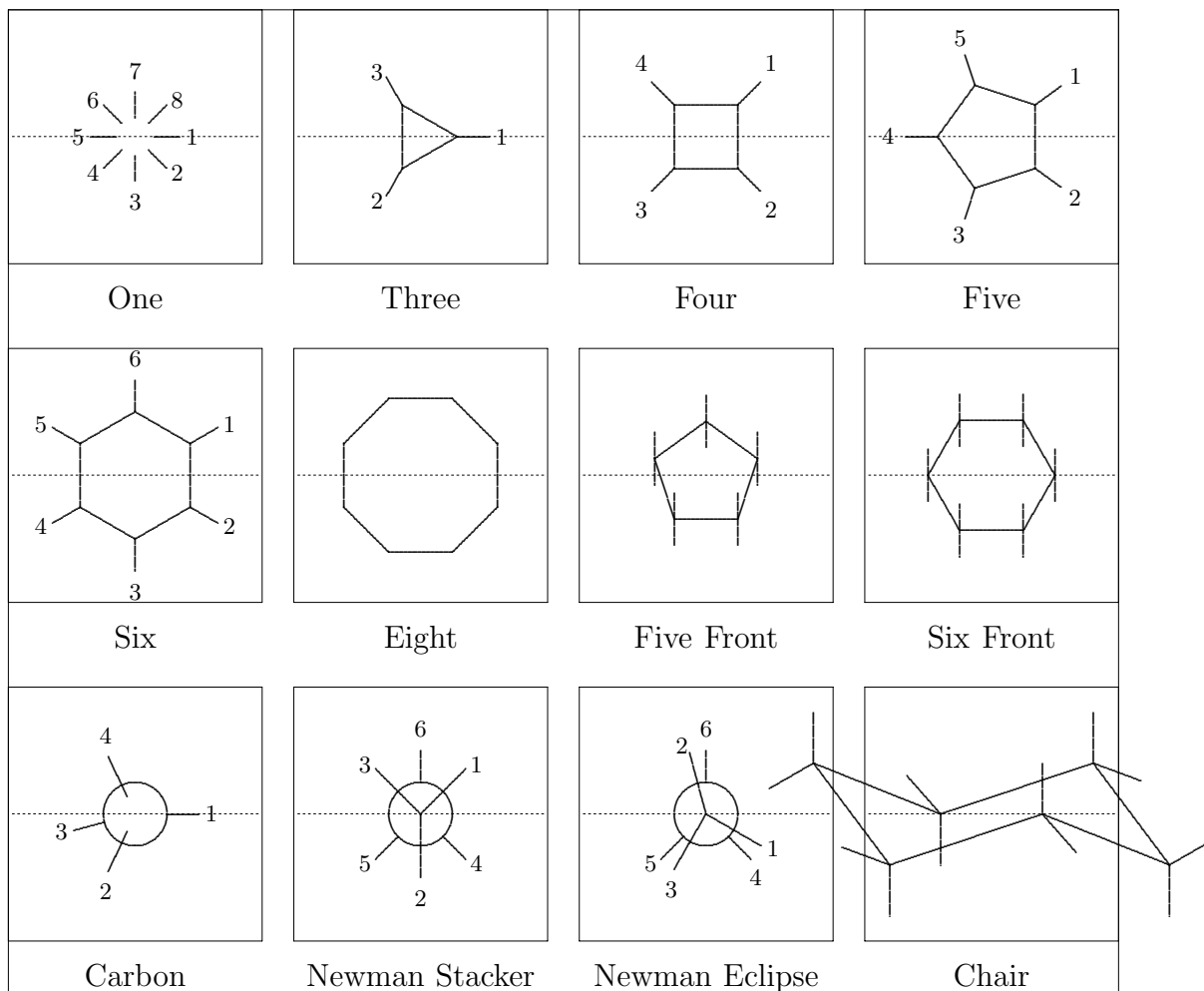

The dimensions of **CHAIR** are somewhat different from the others. This structure is also different in other means. Rotation for example is not possible.

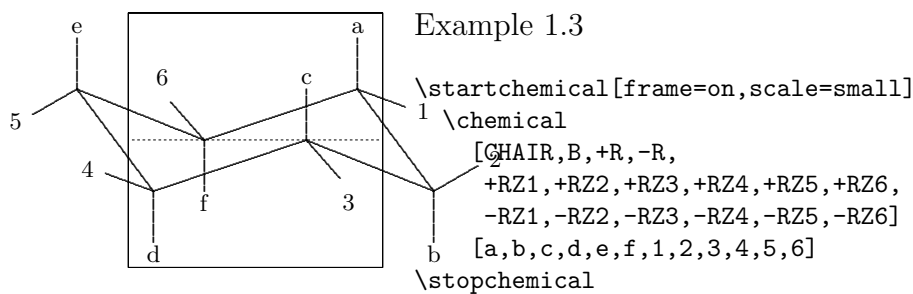

Within a structure the chemical bonds between the C-atoms are defined in the same way. In this example we use B and R. Bonds within a structure are numbered and can be defined by:

```
\chemical[SIX,B1,B2,B3,B4,B5,B6]
\chemical[SIX,B135]
\chemical[SIX,B1..5]
```

These keys draw parts of a sixring. With R and RZ we place substituents on the ring. The key R draws the bond from a ring corner to the substituent ( $\angle 120^\circ$ ). The corner is also identified with a number.

```
\chemical[SIX,B1..6,R1..6]
```

The definition above draws the six bonds in the sixring and the bonds to the substituents. The substituents are identified by the key RZ. Again numbers are used to mark the position. The substituents themselves are defined as text in the second argument.

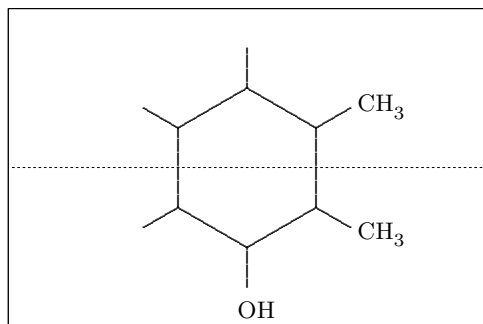

Example 1.4

```
\startchemical[frame=on,width=6000]
\chemical[SIX,B1..6,R1..6,RZ1..3][CH_3,CH_3,OH]
\stopchemical
```

When the second argument is left out no text (substituents) are placed on the ring and the key RZ1..3 has no effect.

## 2 | Bonds

This chapter gives an overview of the bonds you can use in structures. From the examples throughout this manual the use of the different keys will become more meaningful.

Bonds always have two alternatives: a long and a short version. The shortened bonds leave room to place atoms within a structure. A number of bonds can be shortened on both sides left (-) or right (+).

B	Bond	SB	Single Bond
BB	Bold Bond	-SB	Left Single Bond
HB	Hydrogen Bond	+SB	Right Single Bond

Table 2.1 Single bonds.

The example below shows a number of bonds combined within one structure:

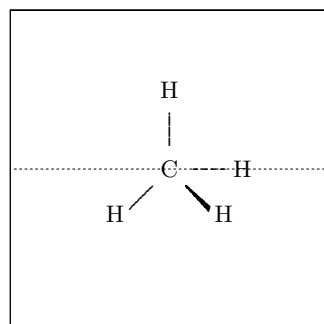

Example 2.1

```
\startchemical[frame=on]
  \chemical[ONE,SD1,SB4,BB2,SB7,Z01247][C,H,H,H,H]
\stopchemical
```

A bond can be followed by one or more numbers or a range, for example: B1, B135 and B1..5. When you want to draw all bonds you can type B.

Within a ring structure you can define extra bonds between atoms, for example a double or triple bond.

EB	Extra Bond	DB	Double Bond
		TB	Triple Bond

Table 2.2 Multiple bonds.

Free electrons and electron pairs can be defined in different ways. The accompanying keywords start with an E.



ES	Extra Single	ED	Extra Double
EP	Extra Pair	ET	Extra Triple

Table 2.3 Free electrons and electron pairs.

The example below shows a carbon atom with 8 outer electrons arranged in a chemically very peculiar way.

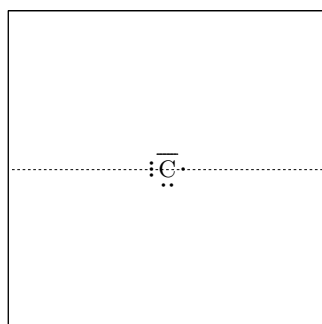

Example 2.2

```
\startchemical[frame=on]
\chemical[ONE,Z0,ES1,ED3,ET5,EP7][C]
\stopchemical
```

Within a ring structure you can make a shortcut from one atom to another. In that case the atom that you want to skip has to be identified. As a replacement of the double bonds in an aromatic sixring a circle can be drawn and charges can be placed within the ring.

SS	Short Shortcut	S	Shortcut
-SS	Left Short Shortcut	MID	Open Mid Shortcut
+SS	Right Short Shortcut	MIDS	Closed Mid Shortcut

Table 2.4 Special bonds.

C	Circle	CD	Dashed Circle
CC	Shifted Circle	CCD	Dashed Shifted Circle

Table 2.5 Circle bonds.

An example will explain the use of the circular bond and the use of displaced charges.

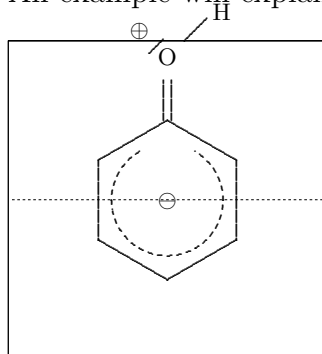

Example 2.3

```
\startchemical[frame=on]
\chemical
[SIX,B,ER6,CCD12346,Z0,PB:RZ6,ONE,SB8,EP6,Z0,ZT6,Z8,PE]
[\ominus,0,\oplus,H]
\stopchemical
```

Substituents can be connected to all corners of a structure. A substituent can be anything you want. It depends on the presence of atoms or molecules whether the bonds are long or short. In the examples you will see a great number of the keys that are used to define substituents.

R	Radical	SR	Single Radical
-R	Left Radical	-SR	Single Left Radical
+R	Right Radical	+SR	Single Right Radical

Table 2.6 Bonds to substituents.

There are a few alternatives to draw bridges.

RD	Radical Dashed	RB	Radical Bold
-RD	Left Radical Dashed	-RB	Left Radical Bold
+RD	Right Radical Dashed	+RB	Right Radical Bold

Table 2.7 Special bonds to substituents.

Radicals can be drawn in three ways.<sup>3</sup> Some alternatives are seldom used.

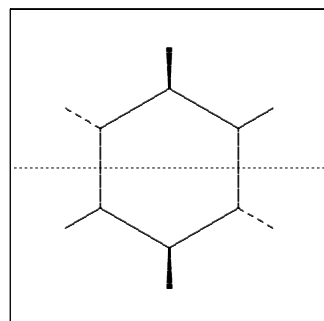

Example 2.4

```
\startchemical[frame=on]
\chemical[SIX,B,R14,RD25,RB36]
\stopchemical
```

SD	Single Dashed	LDD	Left Double Dashed
OE	Open Ended	RDD	Right Double Dashed

Table 2.8 More special bonds to substituents.

An example of an *Open Ended* is defined below. We see a sixring (SIX) with a number of consecutive OEs. The use of PB is explained later.

<sup>3</sup>The word radical should not be interpreted chemically, but typographically.

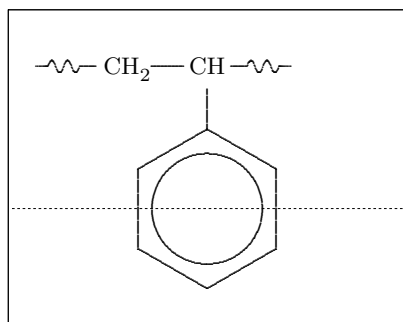

Example 2.5

```
\startchemical
  [width=5000,top=2500,bottom=1500,frame=on]
\chemical
  [SIX,B,C,R6,
  PB:RZ6,ONE,CZ0,OE1,SB5,MOV5,CZ0,OFF5,OE5,PE]
  [CH,CH_2]
\stopchemical
```

It's obvious that substituents can be attached to the structure by means of double bonds.

ER	Extra Radical	DR	Double Radical
----	---------------	----	----------------

Table 2.9 Double bonds to substituents.

You can comment on a bond. Text is typed in the second argument of `\chemical`.

Z	Atom	RZ	Radical Atom
CRZ	Center Atom	-RZ	Left Radical Atom
MIDZ	Mid Atom	+RZ	Right Radical Atom

Table 2.10 Atoms and molecules (radicals).

From these keys RZ is an addition to the key R. The key MID is only available in combination with a sixring (SIX). In the example below we see the effects of MID and MIDZ. These keys have no positioning parameter.

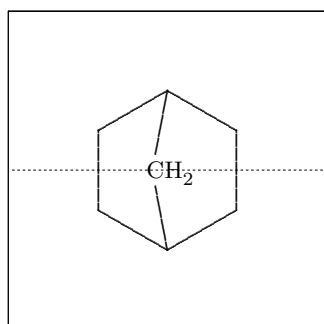

Example 2.6

```
\startchemical[frame=on]
\chemical[SIX,B,MID,MIDZ][\SL{CH_2}]
\stopchemical
```

Atoms and molecules are numbered clockwise. Combinations are also allowed. Position 0 (zero) is the middle of a structure.

We can attach labels and numbers to an atom or a bond. This is done with ZN and ZT:

ZN	Atom Number	ZT	Atom Text
----	-------------	----	-----------

Table 2.11 Labels and numbers.

In case of a **SIX** and a **FIVE** we can also attach text to radicals. We use **RN** and **RT**.

RN	Radical Number	RT	Radical Text
RTN	Radical Top Number	RTT	Radical Top Text
RBN	Radical Bottom Number	RBT	Radical Bottom Text

Table 2.12 Labels and numbers.

The structure **ONE** has also a top and bottom alternative.

ZTN	Atom Top Number	ZTT	Atom Top Text
ZBN	Atom Bottom Number	ZBT	Atom Bottom Text

Table 2.13 Extra labels and numbers.

With the keys **ZTN** and **ZBN** numbers are generated automatically. The other keys will use the typed text of the second argument of **chemical**.

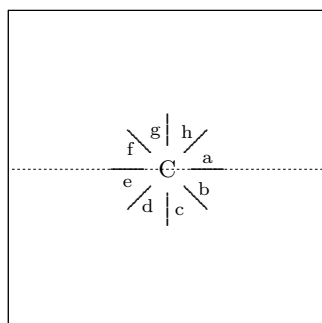

Example 2.7

```
\startchemical[frame=on]
  \chemical[ONE,SB,ZO,ZTT][C,a,b,c,d,e,f,g,h]
\stopchemical
```

You can also add some symbols to the structure.

AU	Arrow Up	AD	Arrow Down
----	----------	----	------------

Table 2.14 Indications.

The arrows are positioned between the atoms in a structure.

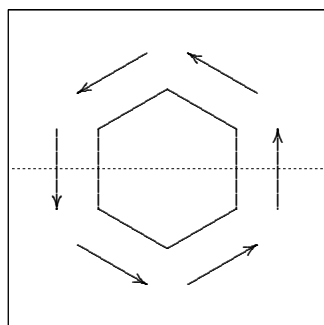

Example 2.8

```
\startchemical[frame=on]
\chemical[SIX,B,AU]
\stopchemical
```

We want to add that while typesetting atoms and molecules the dimensions of these atoms and molecules are taken into account. The width of  $C$  and the height of  $C_m^n$  play an important role during positioning. This mechanism may be refined in a later stage.

## 3 | Frontviews

Structures FIVE and SIX can be displayed in a frontview. However there are some limitations. Frontviews can not be rotated. Also the coupling of several structures is limited.

We illustrate the frontview keys in two examples.

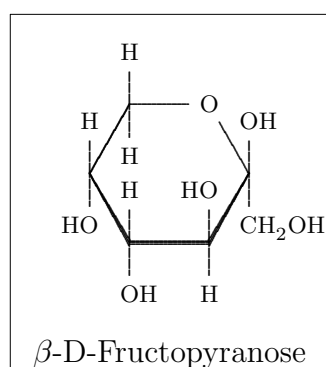

Example 3.1

```
\startchemical [height=4500,bottom=2500]
  \bottext{\beta-D-Fructopyranose}
  \chemical
    [SIX,FRONT,BB1236,+SB4,-SB5,Z5] [0]
  \chemical
    [SIX,FRONT,+R12346,+RZ12346] [\SR{HO},H,H,H,OH]
  \chemical
    [SIX,FRONT,-R12346,-RZ12346] [H,OH,\SR{HO},H,CH_2OH]
\stopchemical
```

Positioning the radicals is an optimization of feasibility and quality. The next example will illustrate this.

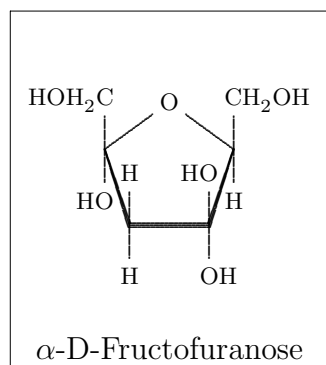

Example 3.2

```
\startchemical [height=4500,bottom=2500]
  \bottext{\alpha-D-Fructofuranose}
  \chemical
    [FIVE,FRONT,BB125,+SB3,-SB4,Z4] [0]
  \chemical
    [FIVE,FRONT,+R1235,+RZ1235] [\SR{HO},H,\SR{HOH_2C},CH_2OH]
  \chemical
    [FIVE,FRONT,-R1235,-RZ1235] [OH,H,\SR{HO},H,CH_2OH]
\stopchemical
```

## 4 | Definitions

It is possible to build a library of structures. These predefined structures can be used in a later stage, for example as a component of a more complex structure. Predefinition can be done with the T<sub>E</sub>X-primitive `\def`.

```
\def\sixring{\chemical[SIX,B,R,RZ]}
```

However it is better to use the command `\definechemical`. In that case a message will occur during processing if a duplicate name is found.

```
\definechemical[sixring]
  {\chemical[SIX,B,R,RZ]}
```

Recalling `\chemical[sixring]` will display a bare sixring without substituents.

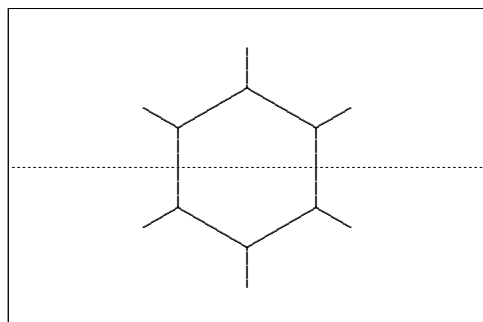

Example 4.1

```
\definechemical[sixring]
  {\chemical[SIX,B,R,RZ]}

\startchemical[frame=on,width=6000]
  \chemical[sixring]
\stopchemical
```

If we want to attach six substituents in a later stage to a sixring we could type:

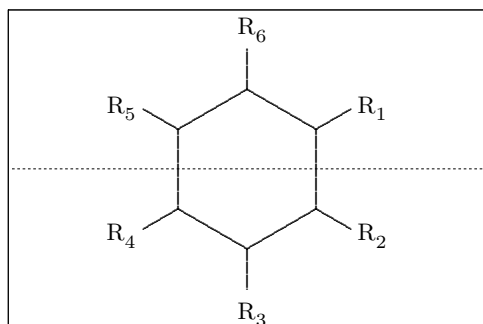

Example 4.2

```
\definechemical[sixring]
  {\chemical[SIX,B,R,RZ]}

\startchemical[frame=on,width=6000]
  \chemical[sixring][R_1,R_2,R_3,R_4,R_5,R_6]
\stopchemical
```

The structure `sixring` can be defined without substituents (`RZ`). We could attach them after recalling `\chemical[sixring]`.

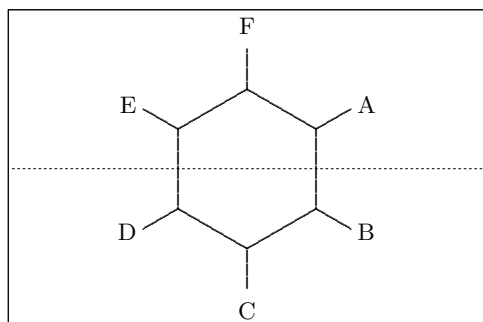

Example 4.3

```
\definechemical[sixring]
  {\chemical[SIX,B,R]}

\startchemical[frame=on,width=6000]
  \chemical[sixring,RZ][A,B,C,D,E,F]
\stopchemical
```

In principal the possibilities are unlimited. However, you should remember that atoms and molecules are selected from the second argument in the order of definition in the first argument.

A definition may contain atoms and molecules (texts).

```
\definechemical[sixring]
  {\chemical[SIX,B,R,RZ135][R_1,R_3,R_5]}
```

In the example above there will always be three substituents. If we want to attach more substituents we have to indicate explicitly that we want to continue with the sixring (SIX).

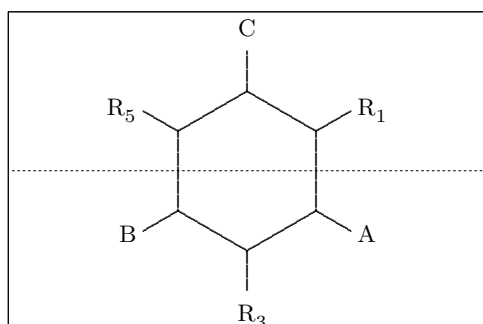

Example 4.4

```
\definechemical[sixring]
  {\chemical[SIX,B,R,RZ135][R_1,R_3,R_5]}

\startchemical[frame=on,width=6000]
  \chemical[sixring,SIX,RZ246][A,B,C]
\stopchemical
```

In a definition `\chemical[]` has a global scope (this means that `SIX` is remembered) and `\chemical[] []` has a local scope. The idea behind this is that in the first case a range of keys can be added and in the second case a complete structure.

In a definition `\chemical` may be used more than once. The last example could have been defined thus:



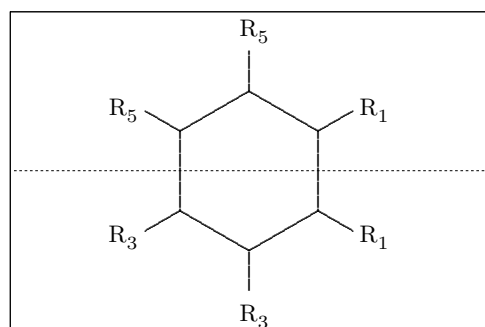

Example 4.5

```

\definechemical[sixring]
  {\chemical[SIX,B,R,RZ135][R_1,R_3,R_5]
  \chemical[SIX,RZ246]}

\startchemical[frame=on,width=6000]
  \chemical[sixring][A,B,C]
\stopchemical

```

When  $\text{T}_{\text{E}}\text{X}$  announces that an `unknown` command has occurred, you may have forgotten to type `SIX`, `FIVE` or a comparable key.

## 5 | Combinations

Structures can be combined to more complex compounds. Moving one structure in relation to another structure is done by `MOV`, `ROT`, `ADJ` and `SUB`.

<code>MOV</code>	Move	moving a comparable structure structure in the direction of a bond
<code>ADJ</code>	Adjace	moving another structure in the direction of the $x$ - or $y$ -axis, adjacent to a bond
<code>SUB</code>	Substitute	moving one structure in relation to another in the direction of the $x$ - or $y$ -axis
<code>ROT</code>	Rotate	rotating a structure

Table 5.1 Moving and rotating.

The four keys mentioned above have different effects when they are applied to different structures. The angle of rotation in `\chemical[FIVE,ROT1,B]` differs from that in `\chemical[SIX,ROT1,B]`.

With the structure `ONE` you can use `MOV` but the key `DIR` is also available. Both keys have the same effect but differ in spacing. Small adjustments are possible with `OFF`.

<code>DIR</code>	Direction	moving a structure in a diagonal direction
<code>OFF</code>	Offset	moving atoms and molecules over small distances

Table 5.2 Moving and rotating.

The structure `CARBON` can be mirrored with `MIR`.

<code>MIR</code>	Mirror	mirroring a structure
------------------	--------	-----------------------

Table 5.3 Mirroring.

We use a number to indicate the direction of a movement or the level of rotation. These keys are closely related with the structure. Therefore they have to be defined before bonds are drawn and texts are placed. So definition `\chemical[FIVE,B,ROT1,R]` and `\chemical[FIVE,ROT1,B,R]` will not have the same result. The first definition will give an undesirable result.

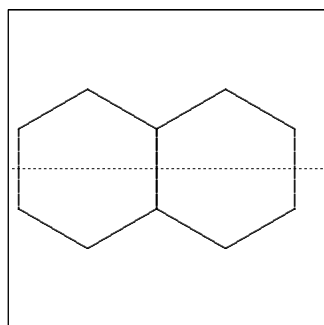

Example 5.1

```
\startchemical[frame=on,width=4000,right=3000]
\chemical[SIX,B,MOV1,B]
\stopchemical
```

In this example a sixring is drawn because of `SIX,B`. Then a movement in the direction of bond 1 takes place and a second sixring is drawn: `B` (`SIX` is stil in effect).

A movement with `MOV` in a sixring can occur in six directions. A movement with `ADJ` will take place in only four axis-directions ( $x, -x, y, -y$ ). It is a coincidence that in a sixring some of these movements have the same effect. The example above could have been drawn with: `[SIX,B,ADJ1,B]`.

Structures can be combined. It is possible for example to combine structure `FIVE` with structure `SIX` in such a way that they have one mutual bond. Luckily the mechanism that takes care of these kinds of combinations is hidden for the user. In the next example you will see a sixring drawn by `SIX,B`. Then a movement in the positive  $x$ -direction is done by `ADJ1`. At last a rotated fivering is drawn: `FIVE,ROT3,B`.

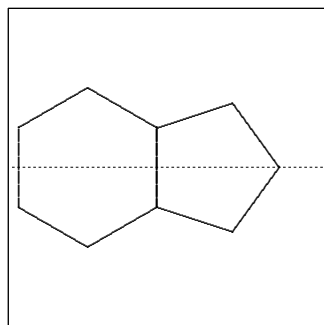

Example 5.2

```
\startchemical[frame=on,width=4000,right=3000]
\chemical[SIX,B,ADJ1,FIVE,ROT3,B]
\stopchemical
```

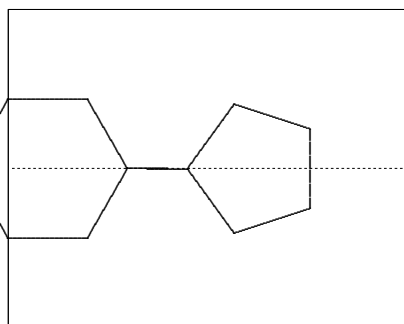

Example 5.3

```
\startchemical[frame=on,width=5000,right=4500]
\chemical[SIX,ROT2,B,R6,SUB1,FIVE,B,R4]
\stopchemical
```

To go from one structure to an adjacent one is done with ADJ. Most of the time one of these structures will have to be rotated to obtain a good attachment. This is done by ROT. Rotations are always clockwise in steps of  $90^\circ$ . When a structure is attached with a bond you will have to use SUB. Movements with ADJ and SUB take place in the four directions of the  $x$ - and  $y$ -axis.

The next examples illustrate that the dimensions of the smaller structures are determined by the larger structures, especially SIX. You will notice that EIGHT has fewer possibilities than SIX.

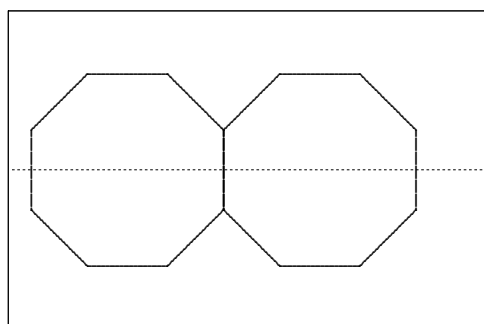

Example 5.4

```
\startchemical[width=6000,left=1500,frame=on]
\chemical[EIGHT,B,MOV1,B]
\stopchemical
```

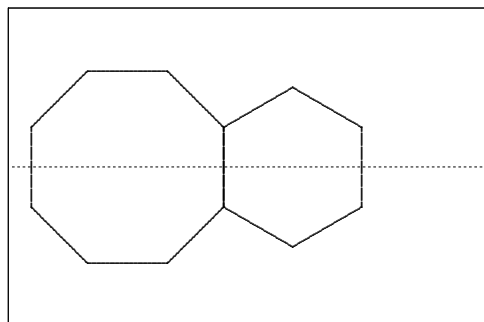

Example 5.5

```
\startchemical[width=6000,left=1500,frame=on]
\chemical[EIGHT,B,ADJ1,SIX,B]
\stopchemical
```

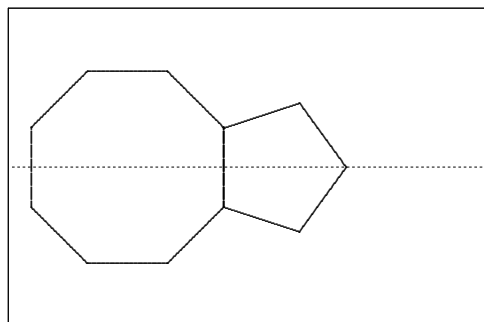

Example 5.6

```
\startchemical[width=6000,left=1500,frame=on]
\chemical[EIGHT,B,ADJ1,FIVE,ROT3,B]
\stopchemical
```

It will be clear by now that the order in which the keys are defined makes a lot of difference. The order should be:

```

\chemical
  [structure,                % SIX, FIVE, ...
   bonds within the structure, % B, C, EB, ...
   bonds pointing to substituents, % R, DR, ...
   atoms within the structure, % Z
   substituents attached to the structure] % RZ, -RZ, ...
  [atoms,
   substituents]

```

Most of the time putting structures together is done by translating and rotating. You could automate this process. In earlier versions this was done automatically, however this led to misinterpretations of users concerning the positions of bonds, atoms and substituents. A structure that consists of more than one component can best be defined per component, translations included. Rotations should wait until the last step.

A sixring may have substituents consisting of a carbon chain. In those situations we use DIR to build the chain.

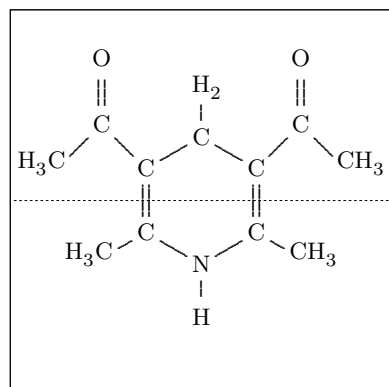

Example 5.7

```

\startchemical
  [scale=small,width=6000,height=6000,frame=on]
  \chemical[SIX,SB2356,DB14,Z2346,SR36,RZ36]
  [C,N,C,C,H,H_2]
  \chemical[PB:Z1,ONE,Z0,DIR8,Z0,SB24,DB7,Z27,PE]
  [C,C,CH_3,0]
  \chemical[PB:Z5,ONE,Z0,DIR6,Z0,SB24,DB7,Z47,PE]
  [C,C,H_3C,0]
  \chemical[SR24,RZ24]
  [CH_3,H_3C]
\stopchemical

```

Because chains have no predefined format the chains are build and positioned as a substructure. For positioning we use the keys PB and PE.

PB: . .	Picture Begin	beginning a substructure
PE	Picture End	ending a substructure

Table 5.4 Positioning.

Directly after PB you will have to define the location where the substructure is positioned. The first following atom is centered on that location. Always use a central atom on this location.

These keys were introduced after trying to obtain structures that are typeset in an acceptable quality. There are different ways to define structures. The following alternative would have resulted in:

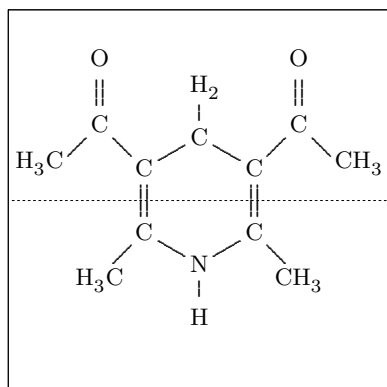

Example 5.8

```
\startchemical
  [scale=small,width=6000,height=6000,frame=on]
\chemical
  [SIX,SB2356,DB14,Z36,SR36,RZ36] [N,C,H,H_2]
\chemical
  [PB:Z1,ONE,Z0,DIR8,Z0,SB24,DB7,Z27,PE] [C,C,CH_3,0]
\chemical
  [PB:Z5,ONE,Z0,DIR6,Z0,SB24,DB7,Z47,PE] [C,C,H_3C,0]
\chemical
  [PB:Z2,ONE,Z0,DIR2,SB6,CZ0,PE] [C,CH_3]
\chemical
  [PB:Z4,ONE,Z0,DIR4,SB8,CZ0,PE] [C,H_3C]
\stopchemical
```

The most efficient way to define such a structure would be like the example below. Typographically you wouldn't be satisfied.

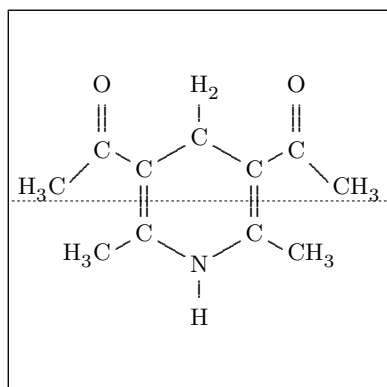

Example 5.9

```
\startchemical
  [scale=small,width=6000,height=6000,frame=on]
\chemical [SIX,SB2356,DB14,Z,SR36,RZ36,SR1245,RZ24]
  [C,C,N,C,C,C,H,H_2,CH_3,H_3C]
\chemical [PB:RZ1,ONE,Z0,SB2,DB7,Z27,PE]
  [C,CH_3,0]
\chemical [PB:RZ5,ONE,Z0,SB4,DB7,Z47,PE]
  [C,H_3C,0]
\stopchemical
```

You may have noticed that the measurements of the structure is determined by the substituents. The chains are not taken into account. This leads to a consistent build-up of a structure.

The differences in outcome when using SUB in stead of PB are very small. However compare the following formulas.

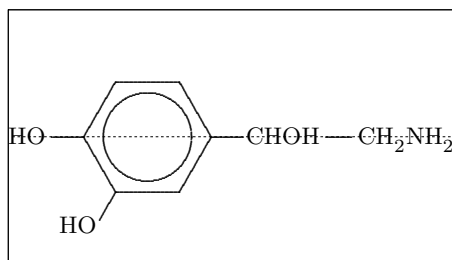

Example 5.10

```
\startchemical
[width=fit,frame=on,scale=small]
\chemical
[SIX,ROT2,B,C,R236,RZ23,
SUB1,ONE,OFF1,ZO,4OFF1,SB1,Z1]
[HO,HO,CHOH,CH_2NH_2]
\stopchemical
```

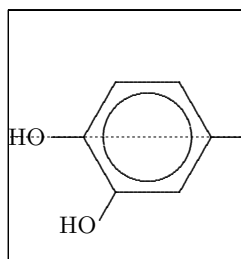

Example 5.11

```
\startchemical
[width=fit,frame=on,scale=small]
\chemical
[SIX,ROT2,B,C,R236,RZ23,
PB:RZ6,ONE,ZO,3OFF1,SB1,Z1,PE]
[HO,HO,CHOH,CH_2NH_2]
\stopchemical
```

The use of the key `PB`: might be somewhat more difficult, but the results are much better. In that case you should define the width yourself, because the substituents are not taken into account when determining the dimensions.

First we will go into the key `OFF`. In some cases atom (`ZO`) in `ONE` can consist of more than one character. The reserved space for these characters would be insufficient and character and bond would overlap. When you need more space for `ZO` we can move bond 1, 2 and 8 by means of the key `OFF` ('offset'). The example below will illustrate its use.

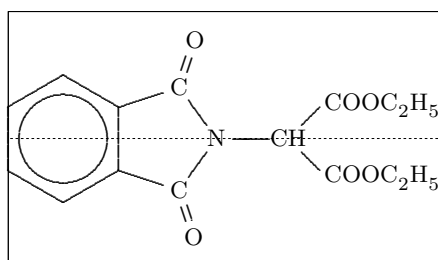

Example 5.12

```
\startchemical
[width=fit,size=small,scale=small,frame=on]
\chemical
[SIX,B,C,ADJ1,
FIVE,ROT3,SB34,+SB2,-SB5,Z345,DR35,SR4,CRZ35,SUB1,
ONE,OFF1,SB258,ZO,Z28]
[C,N,C,O,O,
CH,COOC_2H_5,COOC_2H_5]
\stopchemical
```

Moving the bonds makes room for an extra character. More space was obtained when we would have typed `3OFF1`. The example looks rather complex but you can define it rather easy by defining its components first. Rotating should be done in the last stage.

You see a new key: `CRZ`. This key is used to place the atom or molecule in one line with the bond. You could have used `RZ`, because you can influence spacing in the second argument with `{\,0}` in stead of `0` (spacing in mathematical mode).

We will show another example, produced in two ways. When choosing a method you should take into account the consistency throughout your document.

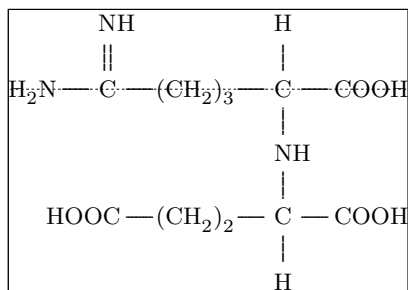

Example 5.13

```
\startchemical
[width=fit,height=fit,frame=on,
scale=small]
\chemical
[ONE,SB15,DB7,Z057,30FF1,MOV1,Z0,30FF1,MOV1,
Z017,SB1357,MOV3,Z0,MOV3,SB1357,Z013,30FF5,
MOV5,Z0,30FF5,SB5,Z5]
[C,H_2N,NH,(CH_2)_3,C,COOH,H,\SL{NH},C,COOH,H,
(CH_2)_2,HOO]
\stopchemical
```

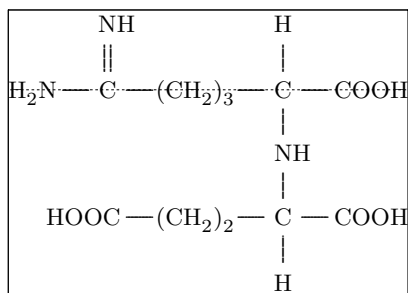

Example 5.14

```
\startchemical
[width=fit,height=fit,frame=on,
scale=small]
\chemical [ONE,SB15,DB7,Z057,30FF1] [C,H_2N,NH]
\chemical [MOV1,Z0,30FF1] [(CH_2)_3]
\chemical [MOV1,Z017,SB1357] [C,COOH,H]
\chemical [MOV3,Z0] [\SL{NH}]
\chemical [MOV3,SB1357,Z013,30FF5] [C,COOH,H]
\chemical [MOV5,Z0,30FF5,SB5,Z5] [(CH_2)_2,HOO]
\stopchemical
```

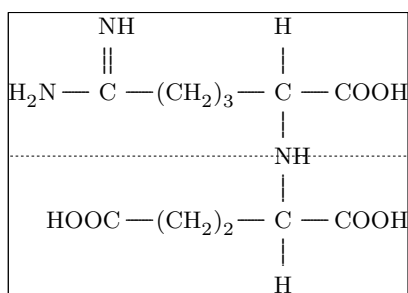

Example 5.15

```
\startchemical
[width=fit,height=fit,frame=on,
scale=small]
\chemical
[ONE,Z0,SAVE,MOV7,SB1357,Z017,30FF5,MOV5,Z0,
30FF5,MOV5,SB15,DB7,Z057,RESTORE,
MOV3,SB1357,Z013,MOV5,30FF5,Z0,60FF5,SB5,Z5]
[\SL{NH},C,COOH,H,(CH_2)_3,C,H_2N,NH,C,COOH,H,
(CH_2)_2,HOO]
\stopchemical
```



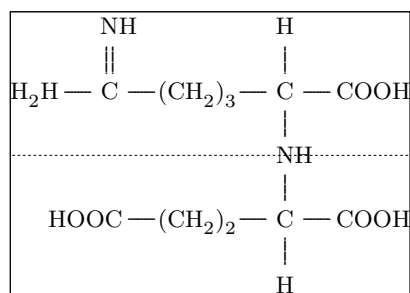

Example 5.16

```

\startchemical
[width=fit,height=fit,frame=on,scale=small]
\chemical
[ONE,Z0,MOV7,SB1357,Z017,30FF5,MOV5,Z0,
30FF5,MOV5,SB15,DB7,Z057,MOV0,MOV3,SB1357,
Z013,MOV5,30FF5,Z0,60FF5,SB5,Z5]
[\SL{NH},C,COOH,H,(CH_2)_3,C,H_2H,NH,C,COOH,H,
(CH_2)_2,HOO]
\stopchemical

```

Notice the use of **SAVE** and **RESTORE**. These keys enable you to save a location in a structure and return to that location in another stage.

As an extra we will show you a combination of **SIX** and **FIVE**. Be aware of the use of **SS**.

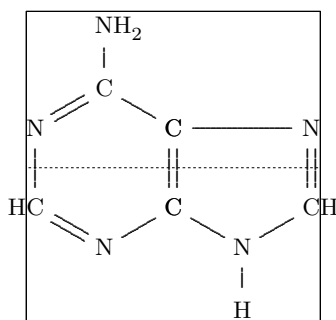

Example 5.17

```

\startchemical
[width=fit,height=fit,frame=on]
\chemical
[SIX,DB135,SB246,Z,SR6,RZ6] [C,C,N,\SR{HC},N,C,NH_2]
\chemical
[SIX,MOV1,DB1,SB23,SS6,Z1..5,SR3,RZ3] [N,\SL{CH},N,C,C,H]
\stopchemical

```

## 6 | Text in structures

We can add text and symbols in and around structures. For example:

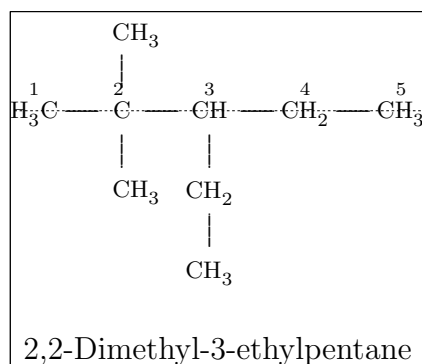

Example 6.1

```
\startchemical
[height=4500,top=1250,width=fit,frame=on]
\bottext
{2,2-Dimethyl-3-ethylpentane}
\chemical
[ONE,Z3570,SB1357]
[CH_3,\T{1}{H_3C},CH_3,\SR{\LT{2}{C}}]
\chemical
[MOV1,OFF1,Z0,SB3]
[\T{3}{CH}]
\chemical
[MOV3,Z0,SB3,MOV3,Z0,MOV7,MOV7]
[CH_2,CH_3]
\chemical
[OFF1,SB1,MOV1,OFF1,Z0,2OFF1,SB1,Z1]
[\T{4}{CH_2},\T{5}{CH_3}]
\stopchemical
```

There is a range of keys like `\T`. In a number of cases the arguments are optional. Charges can be displayed in Roman by means of `\+` and `\-` or directly by means of `\1` up to `\7`.

<code>\+{number}</code>	positive charge in Roman
<code>\-{number}</code>	negative charge in Roman
<code>\1</code>	I (without sign)
<code>\7</code>	II, III, IV, V, VI and VII

Table 6.1 Text: charges.

A charge is centered above the atom. For example:

```
\placeformula
\startformula
\chemical{S}+\chemical{O_2}
\chemical{GIVES}
\chemical{\+{4}{S}\-{2}{O_2}}
\stopformula
```

will result in:

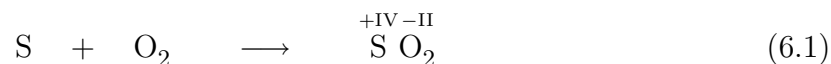

If we want to repeat a number of atoms or molecules we can define an (endless) range with `\[` and `\]`. Both arguments are optional as is shown in the example of PTFE of Polytetrafluorethane, better known as Teflon.

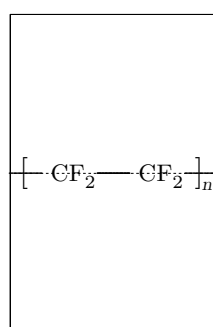
	<p>Example 6.2</p> <pre>\startchemical[width=fit,frame=on]   \chemical     [ONE,ZT5,SB5,OFF1,Z0,OFF1,SB1,MOV1,SB5,OFF1,Z0,OFF1,SB1,ZT1]     [\[,CF_2,CF_2,\]\{s1 n\}]   \stopchemical</pre>
--	---

<code>\{\bottom}</code>	<code>\{\top}\bottom</code>	right repeating sign
<code>\}\bottom</code>	<code>\}\top}\bottom</code>	left repeating sign

Table 6.2 Text: repeating.

There is no problem of placing texts on the left, right, top or bottom of the atoms or molecules. If we precede the keys `\L`, `\R`, `\T` and `\B` by `\X` the distance from text to atoms is somewhat smaller.

<code>\L{text}</code>	text left
<code>\R{text}</code>	text right
<code>\T{text}</code>	text top
<code>\B{text}</code>	text bottom

Table 6.3 Text: around an atom.

Logical combinations of these keys are also possible. A key to centre text is also available.

<code>\TL</code>	<code>\L</code>	<code>\LC</code>	<code>\BL</code>	<code>\TR</code>	<code>\R</code>	<code>\RC</code>	<code>\BR</code>	<code>\LT</code>	<code>\T</code>	<code>\RT</code>	<code>\LB</code>	<code>\B</code>	<code>\RB</code>
<code>\XTL</code>	<code>\XL</code>	<code>\XLC</code>	<code>\XBL</code>	<code>\XTR</code>	<code>\XR</code>	<code>\XRC</code>	<code>\XBR</code>	<code>\XLT</code>	<code>\XT</code>	<code>\XRT</code>	<code>\XLB</code>	<code>\XB</code>	<code>\XRB</code>

In some cases you will need what we may call *smashed* text.

An example is given below. The text is centred around the first character.

<code>\SL{text}</code>	left align
<code>\SM{text}</code>	centre
<code>\SR{text}</code>	right align

Table 6.4 Text: smashed text.

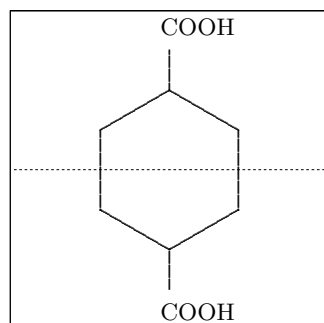

Example 6.3

```
\startchemical[frame=on]
  \chemical[SIX,B,R36,RZ36][\SL{COOH},\SL{COOH}]
\stopchemical
```

We can place text above, under or in the middle of structures with the keys `\toptext`, `\midtext` and `\bottext`. The exact position is determined by the height and depth of the structure.

```
\placeformula
  \startformula
    \startchemical[width=fit]
      \chemical[SIX,B,Z1,MOV1,B][\hbox{${\bullet}$}]
      \toptext{{\sl trans}-Decalin}
    \stopchemical
    \hskip 24pt
    \startchemical[width=fit]
      \chemical[SIX,B,Z12,MOV1,B][\hbox{${\bullet}$},\hbox{${\bullet}$}]
      \bottext{{\sl cis}-Decalin}
    \stopchemical
  \stopformula
```

Both *Decalin* formulas look like this:

*trans*-Decalin

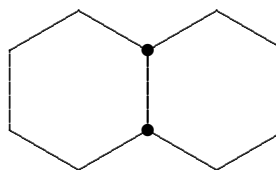
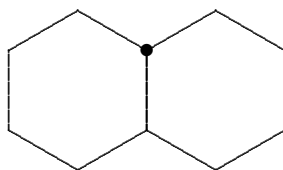

(6.2)

*cis*-Decalin



# 7 | Axis

Structures can be typeset in a frame that is divided by axis. The dimensions of the axis and the location of the origin can be defined in the set up. The axis and the frame can be made visible.

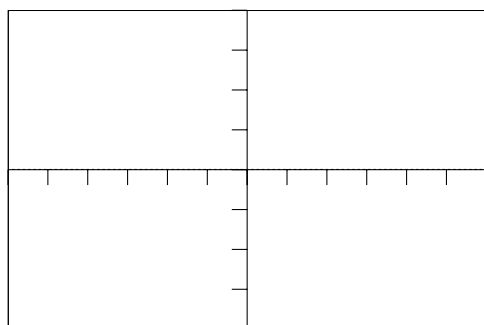

Example 7.1

```
\startchemical
[axis=on,
width=6000,height=4000]
\stopchemical
```

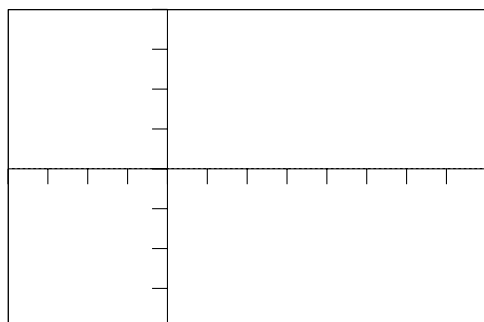

Example 7.2

```
\startchemical
[axis=on,
left=2000,right=4000]
\stopchemical
```

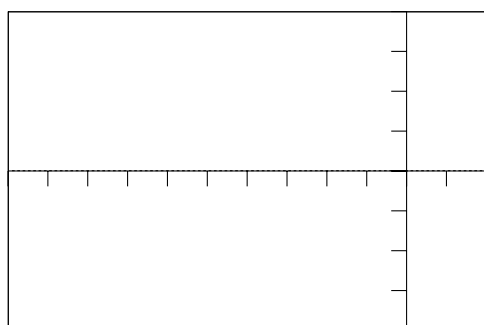

Example 7.3

```
\startchemical
[axis=on,
width=6000,right=1000]
\stopchemical
```

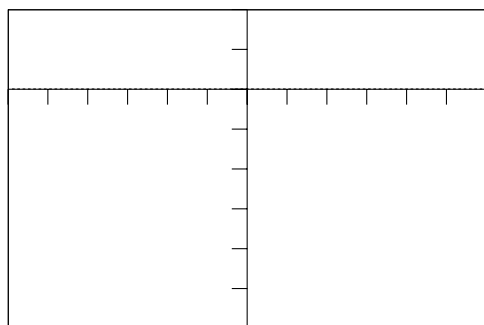

Example 7.4

```
\startchemical
  [axis=on,
   width=6000,top=1000,bottom=3000]
\stopchemical
```

The dimensions of the total structure determine the dimensions of the axis. When `width=fit` and/or `height=fit` is typed the dimensions are determined by the real dimensions. Your choice will depend on how you want to place the structure in the text.

**Example 7.1** shows the default set up. Within a `\start–\stop`-pair you can use `PfTeX`-macros. However, be careful.

## 8 | Set ups

After `\startchemical` and `\setupchemical` you can type the set up.

parameter	values	default
width	number	4000
height	number	4000
left	number	
right	number	
top	number	
bottom	number	
resolution	number	<code>\outputresolution</code>
bodyfont	8pt 9pt 10pt etc.	<code>\bodyfontsize</code>
character	<code>\rm \bf</code> etc.	<code>\rm</code>
scale	number	medium
size	small medium big	medium
state	start stop	start
option	test	
axis	on off	off
frame	on off	off
alternative	1 2	1
offset	HIGH LOW	LOW

Table 8.1 Set ups for structures.

The axis range from  $-2000$  upto  $+2000$ , height as well as width. The parameter `Z0` is at  $(0, 0)$ . Other divisions can be set up with `left`, `right`, `top` and/or `bottom` in combination with `width` and `height`.

You can use the key `size` to set up the bodyfont. In doing so the  $\text{T}_{\text{E}}\text{X}$ -primitives `\textsize`, `\scriptsize` and `\scriptscriptsize` are used. With `scale` you can set up the dimensions of the structure itself. The scale is determined by the parameter `bodyfont`. The values `small`, `medium` and `big` are proportionally related.



The set up of the parameter `bodyfont` is used for calculations and has no consequences for the text. In `CONTEXT` and `LATEX` this set up parameter is coupled to the mechanism that sets the bodyfont.

In `TEX` and `CONTEXT` you can use commands like `\rm`, `\bf` and `\sl` in mathematical mode. `PPCHTEX` uses default `\rm`. With the parameter `character` another alternative can be chosen. In **example 8.1** the substituents are typeset *slanted*.

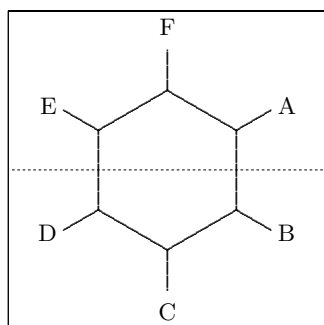

Example 8.1

```
\startchemical[frame=on,character=\sl]
  \chemical[SIX,B,R,RZ][A,B,C,D,E,F]
\stopchemical
```

The set up of `character` is valid for chemical structures in a picture and in the text. The sub- and superscripts are changed accordingly. This is illustrated in  $\text{CH}_4$ ,  $\text{CH}_4$  and  $\text{CH}_4$ , in which the set ups are `\rm`, `\bf` and `\sl`. Italic `\it` formulas lead to a bigger linewidth. In `CONTEXT` default bold-slanted (`\bs`) and bold-italic (`\bi`) are available. These commands adjust automatically to the actual fontstyle:  $\text{CH}_4$ ,  $\text{CH}_4$ ,  $\text{CH}_4$  etc. (`\ss`, `\rm`, `\tt`).

It is also possible to set the characters at the instant you type them in the argument.

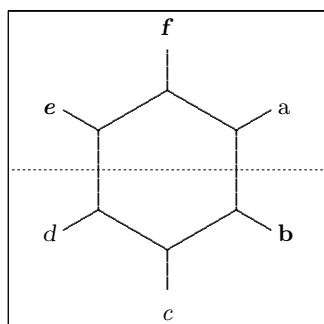

Example 8.2

```
\startchemical[frame=on]
  \chemical[SIX,B,R,RZ][\tf a,\bf b,\it c,\sl d,\bi e,\bs f]
\stopchemical
```

With parameter `state` calculations can be shortcut. The parameters `frame` and `axis` need no further explanation. With `option=test` frames are drawn around the texts in a structure. In this way you can see how the text is aligned.<sup>4</sup> With the parameter `alternative` you can set up the quality of the lines. Default `P1CTEX` uses a 5 point . to draw lines. When option 2 is chosen a thinner line is drawn.

<sup>4</sup>In `CONTEXT` you can activate the visual debugger. When activated the baseline is a dotted line. The module `supp-vis` can be used in other systems.

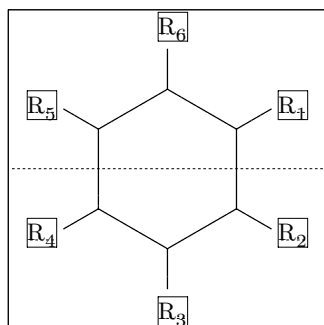

Example 8.3

```
\startchemical[frame=on,option=test,alternative=2]
  \chemical[SIX,B,R,RZ][R_1,R_2,R_3,R_4,R_5,R_6]
\stopchemical
```

The offset relates to the position of the sub- and superscripts. With `HIGH` the subscripts are placed high ( $\text{H}_2\text{O}$ ) and with `LOW` somewhat lower ( $\text{H}_2\text{O}$ ).

A structure can be displayed in different sizes. This is done with `format` and `scale`.

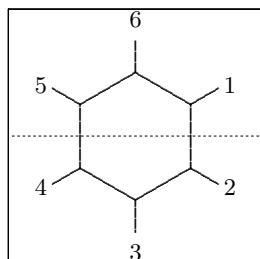

Example 8.4

```
\startchemical[frame=on,scale=small,size=small]
  \chemical[SIX,B,R,RZ][1,2,3,4,5,6]
\stopchemical
```

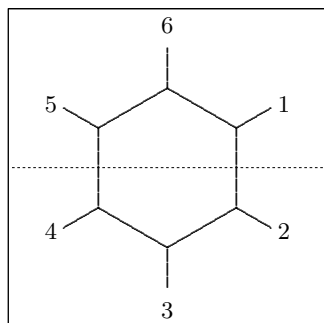

Example 8.5

```
\startchemical[frame=on,scale=medium,size=medium]
  \chemical[SIX,B,R,RZ][1,2,3,4,5,6]
\stopchemical
```

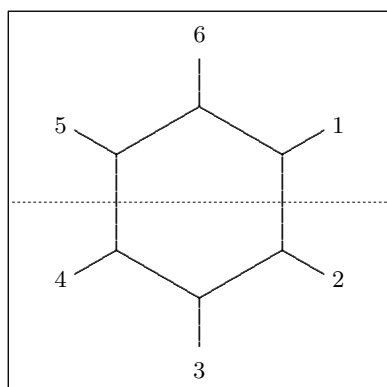

Example 8.6

```
\startchemical[frame=on,scale=big,size=big]
  \chemical[SIX,B,R,RZ][1,2,3,4,5,6]
\stopchemical
```

You can also type a number between 1 and 1000 in `scale`. The values belonging to `small`, `medium` or `big` are proportionally related.

## 9 | Symbols

There are some symbols that can be used to display reactions. The reaction below is typed by:

```

\setupchemical
  [size=small,
   scale=small,
   width=fit,
   height=5500,
   bottom=1500]

\hbox
  {\startchemical
   \chemical[SIX,B,ER6,RZ6][O]
  \stopchemical
  \startchemical
   \chemical[SPACE,PLUS,SPACE]
  \stopchemical
  \startchemical
   \chemical[FIVE,ROT4,B125,+SB3,-SB4,Z4,SR4,RZ4][N,H]
  \stopchemical
  \startchemical
   \chemical[SPACE,GIVES,SPACE][?]
  \stopchemical
  \startchemical
   \chemical[SIX,B,EB6,R6,SUB4,FIVE,ROT4,B125,+SB3,-SB4,Z4][N]
  \stopchemical
  \startchemical
   \chemical[SPACE,PLUS,SPACE,CHEM][H_20]
  \stopchemical}

```

The `\hbox` is necessary to align the structures. The symbols `GIVES` and `PLUS` need no further explanation. With `SPACE` more room can be created between the structures and symbols.

An equilibrium can be displayed with `EQUILIBRIUM`. Over `GIVES` and `EQUILIBRIUM` you can place text. In the example the text is just a `'?'`. In addition `MESOMERIC` is also available. Braces used for displaying complexes can be created with `OPENCOMPLEX` and `CLOSECOMPLEX`.

Explanation

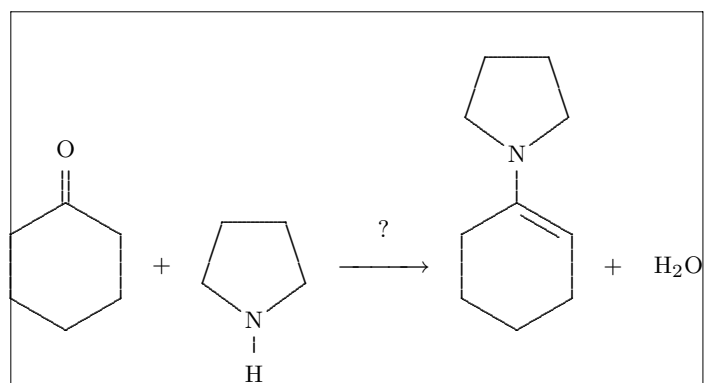

## 10 | Positioning

When you are combining atoms or molecules, for example with `SUB`, some positions and dimensions change their value. To overcome this problem it is possible to save a location with `SAVE` and return to that location with `RESTORE`.

<code>SAVE</code>	Save Status	save actual status
<code>RESTORE</code>	Restore Status	restore actual status

Table 10.1 Positioning.

The keys `SAVE` and `RESTORE` are used with substituents. When placing radicals we use `PB` and `PE`. This example also illustrates the possibility to create chains.

```
\definechemical[molecule]
  {\chemical
    [ONE,ZO,SB1357,
     SAVE,SUB2,SIX,B,R6,C,RESTORE,
     MOV1,ZO,SB137,
     MOV1,ZO,SB37,
     MOV1]
    [C,C,C]}

\startchemical[width=fit,height=fit]
  \chemical[molecule,molecule,molecule]
\stopchemical
```

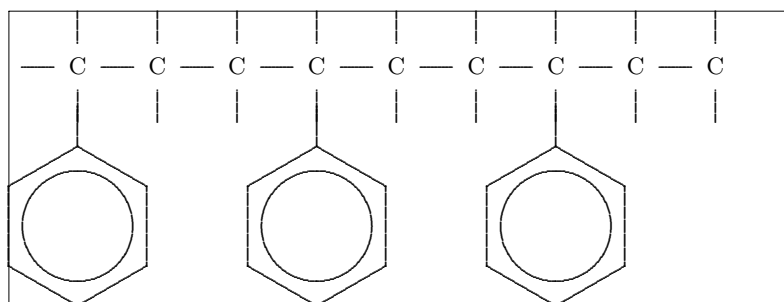

The example below is more complicated and show a complete reaction. The set up of bottom and top is essential in this example.

```

\placeformula
\startformula
\setupchemical
  [width=fit,top=2000,bottom=2000,
  scale=small,size=small]
\startchemical
\chemical
  [ONE,
  SAVE,
  Z0,SB7,SB3,SB1,MOV1,Z0,SB1,MOV1,Z0,DB8,CZ8,SB1,Z1,
  RESTORE,
  SAVE,
  SUB4,ONE,Z0,SB3,SB1,MOV1,Z0,SB1,MOV1,Z0,DB8,CZ8,SB1,Z1,
  RESTORE,
  SUB2,ONE,Z0,SB7,SB1,MOV1,Z0,SB1,MOV1,Z0,DB8,CZ8,SB1,Z1]
[\SR{HC},O,C,O,C_{19}H_{39},
\SR{H_{2}C},O,C,O,C_{17}H_{29},
\SR{H_{2}C},O,C,O,C_{21}H_{41}]
\stopchemical
\startchemical
\chemical [SPACE,PLUS,SPACE]
\stopchemical
\startchemical [right=600]
\chemical [ONE,CZ0] [3CH_{3}OH]
\stopchemical
\startchemical
\chemical [SPACE,GIVES,SPACE,SPACE] [H^+/H_2O]
\stopchemical
\startchemical
\chemical
  [ONE,
  SAVE,
  Z0,SB7,SB3,SB1,Z1,
  RESTORE,
  SAVE,
  SUB4,ONE,Z0,SB3,SB1,Z1,
  RESTORE,
  SUB2,ONE,Z0,SB7,SB1,Z1]
[\SR{HC},OH,
\SR{H_{2}C},OH,
\SR{H_{2}C},OH]
\stopchemical

```

```

\startchemical
  \chemical [SPACE,PLUS,SPACE]
\stopchemical
\startchemical
  \chemical
    [ONE,
     SAVE,
     Z0,DB8,CZ8,SB1,SB5,Z5,MOV1,Z0,SB1,Z1,
     RESTORE,
     SAVE,
     SUB4,ONE,Z0,DB8,CZ8,SB1,SB5,Z5,MOV1,Z0,SB1,Z1,
     RESTORE,
     SUB2,ONE,Z0,DB8,CZ8,SB1,SB5,Z5,MOV1,Z0,SB1,Z1]
  [C,0,C_{19}H_{39},0,CH_{3},
   C,0,C_{17}H_{29},0,CH_{3},
   C,0,C_{21}H_{41},0,CH_{3}]
\stopchemical
\stopformula

```

This definition might have been more compact if we would have typed SB731 in stead of SB7,SB3,SB1. But in this way the definition is readable. Complex structures can best be defined in its respective components.

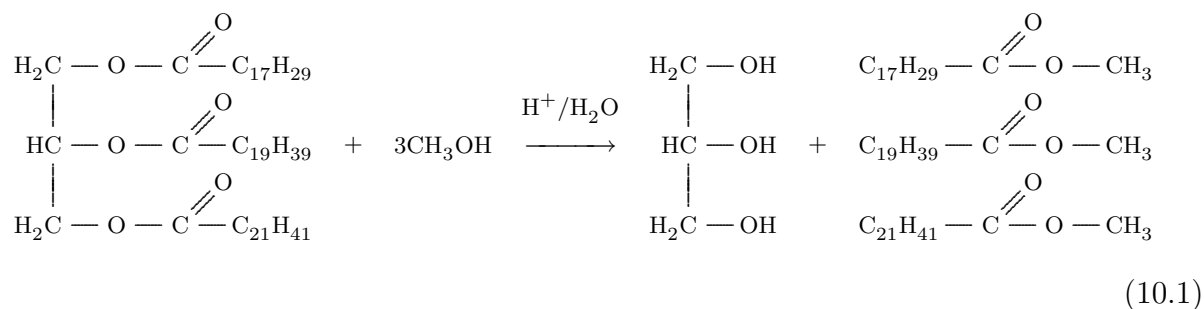

Just two more examples where we place text under a structure.

```

\placeformula
\startformula
  \setupchemical
    [width=fit,top=1500,bottom=3500]
  \startchemical
    \chemical
      [ONE,Z0,DB1,SB3,SB7,Z7,MOV1,Z0,SB3,SB7,Z3,Z7,
       MOV0,SUB2,SIX,B,R6,C]

```

```

[C,H,C,H,H]
\bottext{styreen}
\stopchemical
\quad\quad\quad
\startchemical
\chemical
[ONE,ZO,DB1,SB3,SB7,Z3,Z7,
MOV1,ZO,SB1,SB3,Z3,
MOV1,ZO,DB1,SB3,Z3,
MOV1,ZO,SB3,SB7,Z3,Z7]
[C,H,H,C,H,C,H,C,H,H]
\bottext{1,3-butadien}
\stopchemical
\stopformula

```

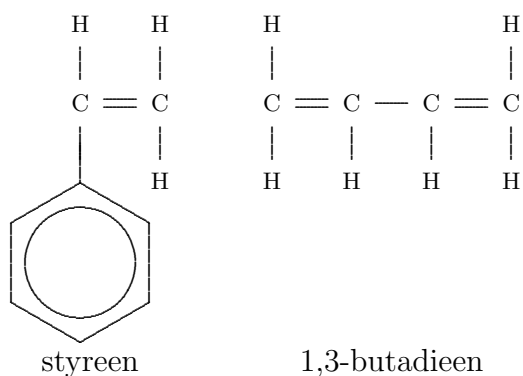

The use of `OFF` can be very subtle. The examples below illustrate this and show minor shifts of `ONE`.

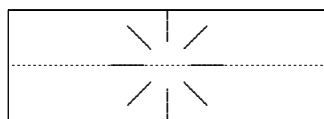

Example 10.1

```

\startchemical[height=fit,frame=on]
\chemical[ONE,SB]
\stopchemical

```

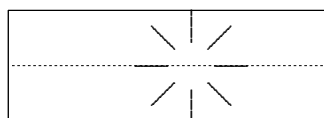

Example 10.2

```

\startchemical[height=fit,frame=on]
\chemical[ONE,3OFF1,SB]
\stopchemical

```



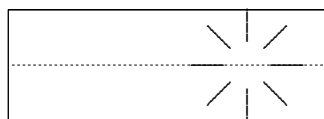

Example 10.3

```
\startchemical[height=fit,frame=on]
\chemical[ONE,MOV1,SB]
\stopchemical
```

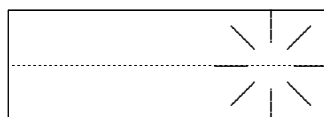

Example 10.4

```
\startchemical[height=fit,frame=on]
\chemical[ONE,3OFF1,MOV1,SB]
\stopchemical
```

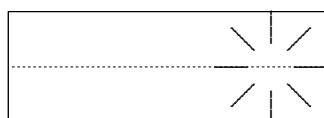

Example 10.5

```
\startchemical[height=fit,frame=on]
\chemical[ONE,MOV1,3OFF1,SB]
\stopchemical
```

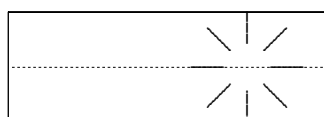

Example 10.6

```
\startchemical[height=fit,frame=on]
\chemical[ONE,MOV1,3OFF1,OFF0,SB]
\stopchemical
```

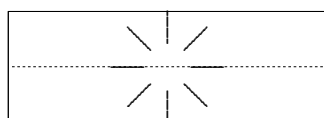

Example 10.7

```
\startchemical[height=fit,frame=on]
\chemical[ONE,MOV1,3OFF1,MOV0,SB]
\stopchemical
```

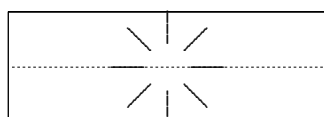

Example 10.8

```
\startchemical[height=fit,frame=on]
\chemical[ONE,MOV1,MOV0,SB]
\stopchemical
```

The next example shows the definition of complexes. Pay special attention to the use of RBT. Normally an extra spacing is not necessary but we use here —the command is not visible— a smaller bodyfont to prevent the structure to run in the margin.

```
\startformula
\setupchemical[scale=small,width=fit]
\startchemical
\chemical[OPENCOMPLEX,SPACE]
\stopchemical
\startchemical
\chemical[SIX,B,EB35,R6,-R1,+R1]
\chemical[SIX,PB:RZ6,ONE,OFF1,Z0,EP57,PE][\SL{OH}]
```

```

\chemical[SIX,-RZ1,+RZ1,RT2][H,Br,\oplus]
\stopchemical
\startchemical
\chemical[SPACE,MESOMERIC,SPACE]
\stopchemical
\startchemical
\chemical[SIX,B,EB25,R6,-R1,+R1]
\chemical[SIX,PB:RZ6,ONE,OFF1,Z0,EP57,PE][\SL{OH}]
\chemical[SIX,-RZ1,+RZ1,RT4][H,Br,\oplus]
\stopchemical
\startchemical
\chemical[SPACE,MESOMERIC,SPACE]
\stopchemical
\startchemical
\chemical[SIX,B,EB24,R6,-R1,+R1]
\chemical[SIX,PB:RZ6,ONE,OFF1,Z0,EP57,PE][\SL{OH}]
\chemical[SIX,-RZ1,+RZ1,RBT6][H,Br,\ \oplus]
\stopchemical
\startchemical
\chemical[SPACE,MESOMERIC,SPACE]
\stopchemical
\startchemical
\chemical[SIX,B,EB24,ER6,-R1,+R1]
\chemical[SIX,PB:RZ6,ONE,OFF1,Z0,EP5,ZT7,PE][\SL{OH},\oplus]
\chemical[SIX,-RZ1,+RZ1][H,Br]
\stopchemical
\startchemical
\chemical[SPACE,CLOSECOMPLEX]
\stopchemical
\stopformula

```

Without the use of `SPACE` the separate structures would merge. Most of the time the optimization of such a reaction is an iterative process.

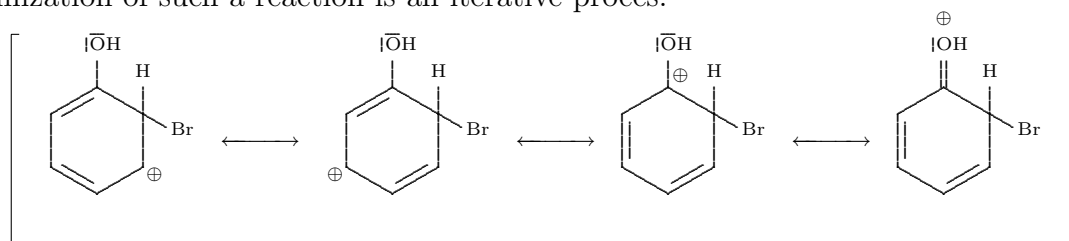

# 11 | Reactions

Not only the typesetting of chemical structures is supported but also the typesetting of normal reactions. The command `\chemical` has three other appearances:

```
\chemical{formula}
\chemical{formula}{bottom text}
\chemical{formula}{top text}{bottom text}
```

This command adapts itself to text mode. That means that it 'knows' whether it is used in:

- text-mode
- mathematical text-mode
- mathematical display-mode

When the command is used in running text it will automatically be surrounded by `$ $`. Typing `\chemical{NH_4^+}` will result in  $\text{NH}_4^+$ .

The result would be the same if we would place the command between `$ $`. In both cases the second and third argument can be left out. If we place the command between `$$ $$` (or `\startformula` and `\stopformula`) both arguments do have a function. First a simple example. The command `\placeformula` is a `CONTEX`T command and handles the positioning and numbering of the formula.

```
\placeformula
\startformula
\chemical{2H_2} \chemical{PLUS} \chemical{O_2}
\chemical{GIVES} \chemical{2H_2O}
\stopformula
```

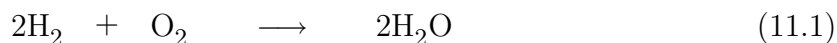

The definition of the chemical part could be somewhat shorter:

```
\chemical{2H_2,PLUS,O_2,GIVES,2H_2O}
```

or even:

```
\chemical{2H_2,+,O_2,->,2H_2O}
```

A T<sub>E</sub>X-addict will notice from these examples that the plus sign and the arrow are on the baseline. Compare for example  $+$  and  $\rightarrow$ . In the reaction you will see that the  $+$  and the  $\rightarrow$  are vertically aligned.

You can use PLUS, GIVES and EQUILIBRIUM ( $\leftrightarrow$ ) in this command. With MESOMERIC or  $\leftrightarrow$  you will get  $\longleftrightarrow$ .

The reaction can be placed in the text. In that case a more compact display is used:  $2\text{H}_2 + \text{O}_2 \rightarrow 2\text{H}_2\text{O}$ . Some finetuning with  $\,$ , would result in  $2\text{H}_2 + \text{O}_2 \longrightarrow 2\text{H}_2\text{O}$ .

It is also possible to display bonds in textmode. For example if you want  $\text{H}-\text{CH}=\text{HC}-\text{H}$  you should type `\chemical{H,SINGLE,CH,DOUBLE,HC,SINGLE,H}` or something like this `\chemical{H,-,CH,--,HC,-,H}`. A triple bond can be defined as TRIPLE or ---:  $\text{HC}\equiv\text{CH}$ .

We return two the display-mode. The second and third argument can be used to add text to the reaction:

```
\placeformula
\startformula
\chemical{2H_2}{hydrogen} \chemical{PLUS} \chemical{O_2}{oxygen}
\chemical{GIVES}{heat} \chemical{2H_2O}{water}
\stopformula
```

So we can also place text over and under symbols!



The last argument is placed under the compound.



The formula above is defined with:

```
\placeformula
\startformula
\chemical{H_2O}{liquid}{water}
\hbox{c.q.}
\chemical{H_2O}{water}
\stopformula
```

The size of the formulas or reactions in the running text can be set up with:

parameter	set up	default
size	small medium big	big

Table 11.1 Set up in text formulas.

The definition `\chemical{H,SINGLE,CH,DOUBLE,HC,SINGLE,H}` result with `big`, `medium` and `small` in the following formulas:

H—CH=HC—H      H—CH=HC—H      H—CH=HC—H

## 12 | Subscripts

Sub- and superscripts are placed somewhat lower as is recommended by Knuth in the  $\text{T}_{\text{E}}\text{X}$ Book. The rather strange chemical compound that is shown on page 179 of the  $\text{T}_{\text{E}}\text{X}$ Book is defined with `\chemical{Fe_2^{+2}Cr_2O_4}`. This will result in  $\text{Fe}_2^{+2}\text{Cr}_2\text{O}_4$ . Without correction it would have been:  $\text{Fe}_2^{+2}\text{Cr}_2\text{O}_4$ .

The position of the subscript is determined by the parameter `offset`: `HIGH` or `LOW`. This position can be influenced locally (per substituent) as is shown in the example below.

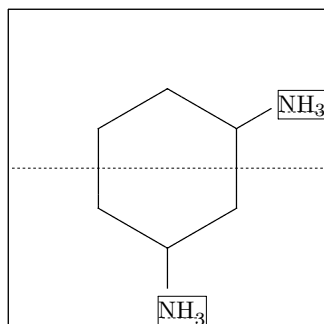

Example 12.1

```
\startchemical[frame=on,option=test,alternative=2]
  \chemical[SIX,B,R13,HIGH,RZ1,LOW,RZ3][NH_3,NH_3]
\stopchemical
```

However, it is recommended to set up this parameter globally to obtain consistent formulas.

The values `LOW` and `HIGH` can also be used in text formulas. For example if you type `\chemical{HIGH,H_2O}` then you will get  $\text{H}_2\text{O}$  and `\chemical{LOW,H_2O}` will become  $\text{H}_2\text{O}$ .

## Part 2 Backgrounds

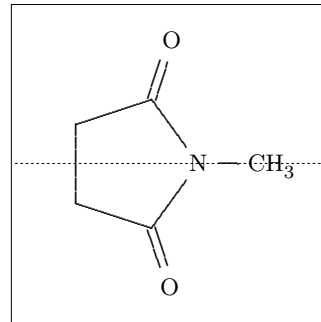

# 1 | Installation

The package `PPCHTEX` is developed for use in combination with `CONTEXT`. `PPCHTEX` is activated in `CONTEXT` by:<sup>1</sup>

```
\usemodule[pictex,chemic]
```

This command loads the `P1CTEX` macros so `PPCHTEX` knows what output is needed. The chemical macros are not automatically available.

The package can be used in combination with `PLAIN TEX` or `LATEX`. In that case the file `m-chemie.sty` is also used. `PPCHTEX` is then activated by `\documentstyle`:

```
\documentstyle[m-pictex,m-chemie]{}
```

In `LATEX2ε` it is somewhat different:

```
\usepackage{m-pictex}
\usepackage{m-chemie}
```

The file `m-pictex` takes care of an efficient loading of `P1CTEX`. This is necessary because `LATEX` allocates a lot of `\dimens`. Because of the userinterface a big version of `TEX` is needed to run `PPCHTEX`.

`PPCHTEX` can be used in three languages. The actual language can be activated by:

language	files
dutch	<code>m-che-nl = m-chemie.sty</code>
english	<code>m-che-en = m-chemic.sty</code>
german	<code>m-che-de = m-chemie.sty</code>

In the file `ppchtex.noc` you can see the coupling between `CONTEXT` and `macropackage`. This file also loads the system modules of `CONTEXT`.

The total distribution consists of the definition files `ppchtex.tex` and `ppchtex.noc` the starting files `m-che-nl.tex`, `m-che-en.tex` and `m-che-de.tex` and the alternative starting files `m-chemie.tex` and `m-chemic.tex`.

<sup>1</sup>The macros in file `ppchtex.tex`, are loaded by typing `m-chemic.tex` (the `m` stands for module).



## 2 | Extensions

Users of `PPCHTEX` are free to use and alter the macros. However one should be careful because most macros are still under development. Some macros may look more complex than necessary, but this is due to the userfriendly interface of `CONTEXT` and `PPCHTEX`.

Commands like `\setup...` make it possible to make readable ASCII-layouts. Compare for example:

```
\setupchemical[size=small]
```

and:

```
\setupchemical  
[size=small,  
scale=500,  
textsize=big]
```

The set up can be defined in a random order and newlines and spaces are not interpreted.

Originally `PPCHTEX` was meant to be a module in `CONTEXT`, therefore the package is multilingual.

If you study the file `ppchtex.tex` you may notice that `\processaction` macros are being used while interpreting the keys in `\chemical[ ]`. These kind of macros are relatively slow but then the `PPCHTEX` interface is very flexible.

## 3 | Fonts

The macros are in mathematical mode and therefore use `\textfont`, `\scriptfont` and `\scriptscriptfont`. When needed the `\fontdimens` 14, 16 and 17 of `\font2` are adapted. The size of the actual font is derived from  $x$  height (`\fontdimen5`).

Changes in `\fontdimen` s have are global, so grouping makes no sense. The dimensions are therefore continually set and reset. This solution may seem poor but alternatives are not failsave and will result in problems with scaled fonts.

Typesetting atoms and molecules (text) during processing are rather time consuming. Speed depends on the complexity of the macro `\rm`.

## 4 | Definitions

The interface of PPCH<sub>TEX</sub> is derived from the CONTEX<sub>T</sub> interface. This means that the interface is multi lingual. The advantage is that one can use PPCH<sub>TEX</sub> in his or her own language. The disadvantage is the fact that macros have to be shared between languages.

At this moment the CONTEX<sub>T</sub> commands and parameters are dutch. PPCH<sub>TEX</sub> however has english commands.

```
\startchemical
  \chemical[SIX,B,C]
\stopchemical
```

Set ups are more difficult. We use system constants and variables that are dutch. In due time these will be translated. Adaption of these constants and variables is not too difficult.

```
\setupchemical[\c!breed=10cm,\c!height=\v!passend]
```

Parameters are preceded by \c! and set ups by \v!. This only works when ! is a character. That is the reason that these set ups have to be surrounded by \unprotect and \protect. For example:

```
\unprotect

\setupchemical[\c!width=10cm,\c!height=\v!passend]

\startchemical
  \chemical[SIX,B,C]
\stopchemical
```

```
\protect
```

More information on the interface can be found in the documentation of the CONTEX<sub>T</sub> modules from the mult group.

## 5 | Color

In `CONTEXT` you can colorize parts of a structure. In **example 5.1** the substituent as well as the bond are colored red.

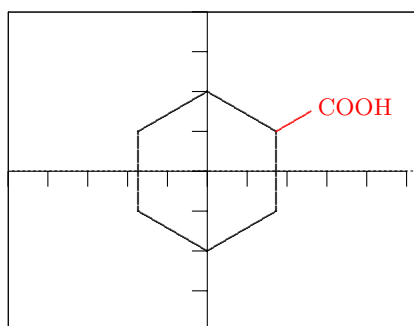

Example 5.1

```
\startchemical[axis=on,frame=on,width=5000]
\chemical[SIX,B]
\color[red]{\chemical[SIX,R1,RZ1][COOH]}
\stopchemical
```

First the color mechanism has to be activated by `\setupcolors[state=start]`.

## 6 | Interaction

In combination with `CONTEXT` `PPCHTEX` supports interactive texts. An interactive text is a text that can be consulted on a computerscreen and contains many hyperlinked textareas. This means that clicking on such an area will result in a jump to the target area.

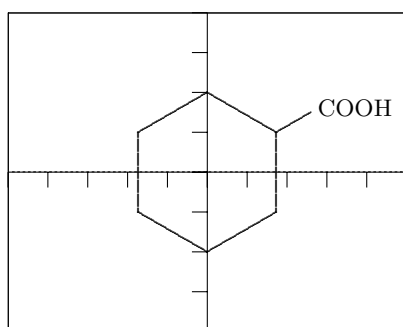

Example 6.1

```
\startchemical[axis=on,frame=on,width=5000]
\chemical[SIX,B]
\chemical[sub:cooh][SIX,R1,RZ1][COOH]
\stopchemical
```

We see a new argument: the reference `[sub:cooh]`. This means that we can refer from the text `COOH` to the structure with:

```
... text ... \goto{\chemical{COOH}}[sub:cooh] ... text ...
```

In this definition `\goto` is a `CONTEXT`-command. We can also refer from the structure to a particular part of the text.

Clicking in `COOH` in the structure results in a jump to the text that is marked with:

```
\paragraph[txt:cooh]{Substituents}
```

```
... text ... \chemical{COOH} ... text ...
```

A combination is also possible. In that case it is necessary to mark the reference with `\chemical` and to refer in the text with `\gotochemical`.

The coupling of the interaction mechanism is done with macros:

```
\localgotochemical {reference} {text}
\localthisischemical {reference}
```

You can see the `CONTEXT` sources for more information.

## Part 3 Overview

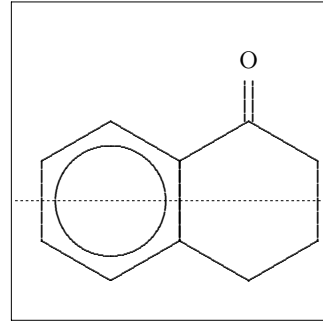

1 | One

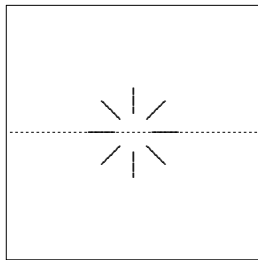

SB

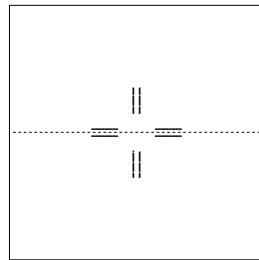

DB

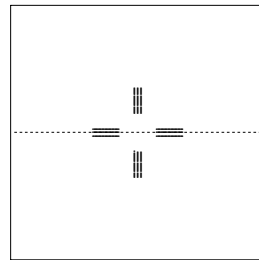

TB

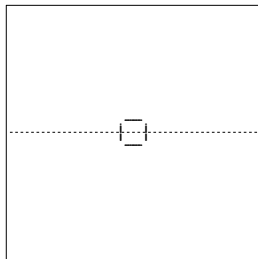

EP

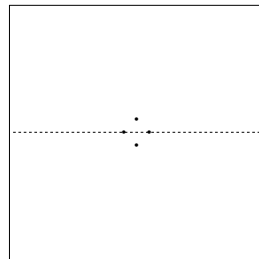

ES

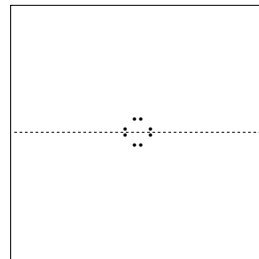

ED

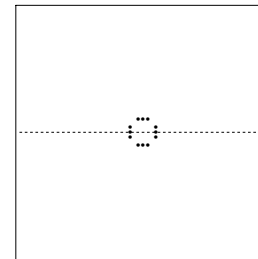

ET

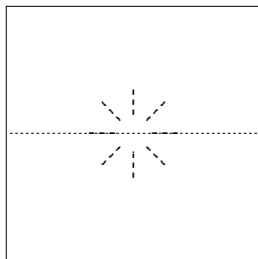

SD

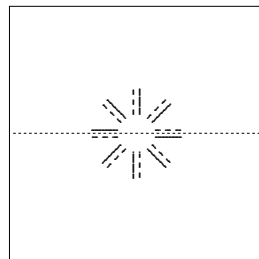

LDD

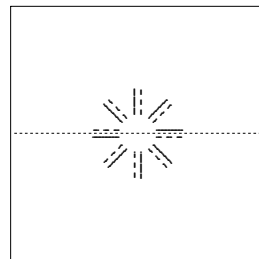

RDD

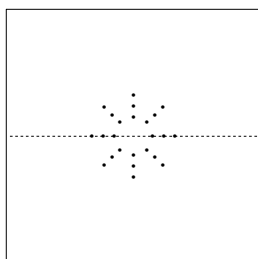

HB

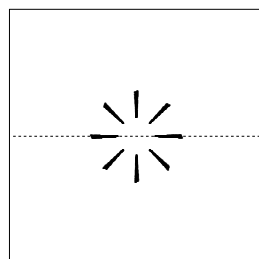

BB

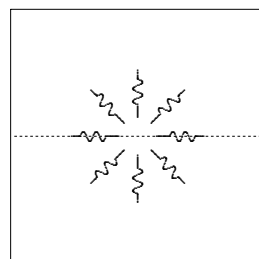

OE

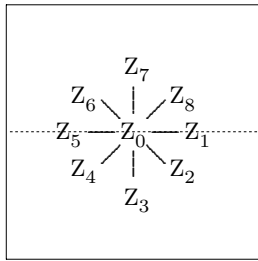

Z

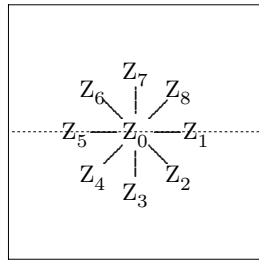

CZ

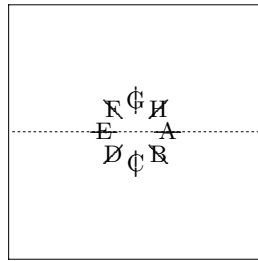

ZT

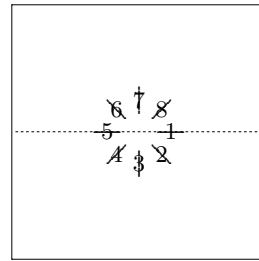

ZN

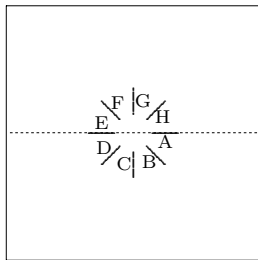

ZBT

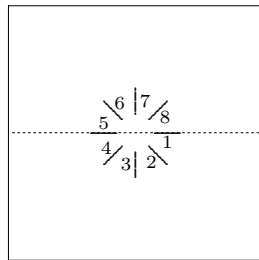

ZBN

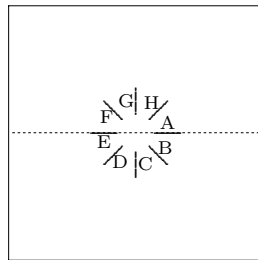

ZTT

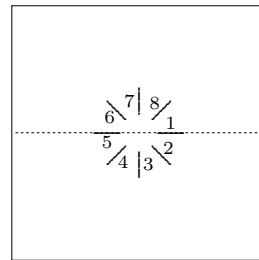

ZTN

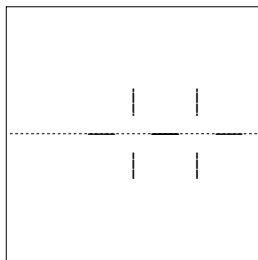

MOV

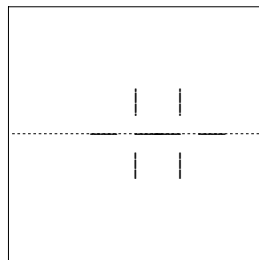

DIR

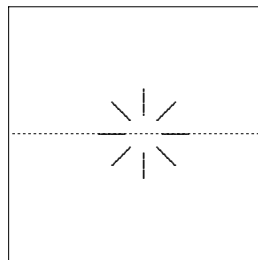

OFF



2 | Three

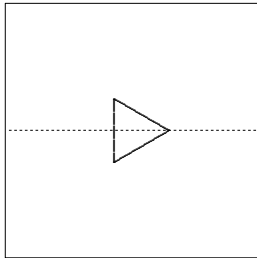

B

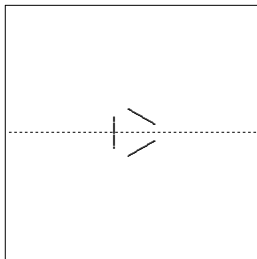

SB

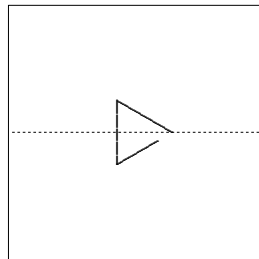

-SB

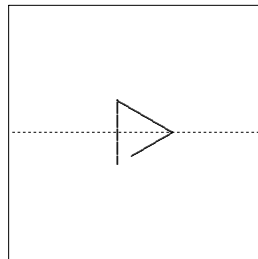

+SB

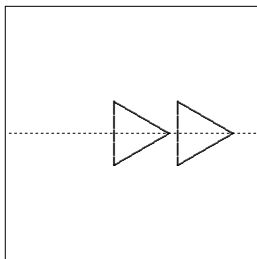

MOV

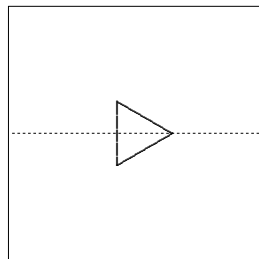

ROT

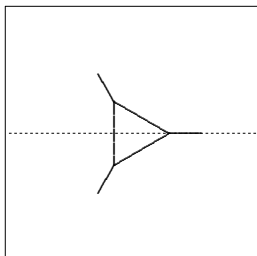

R

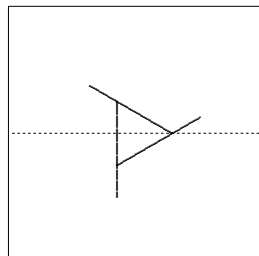

-R

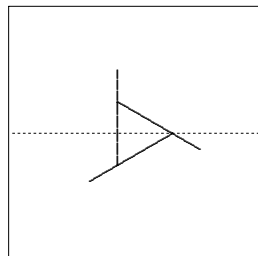

+R

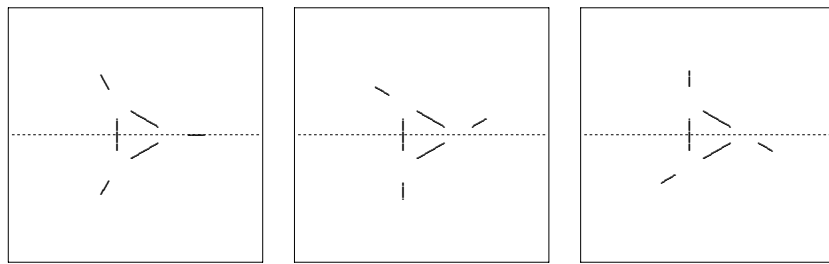

SR

-SR

+SR

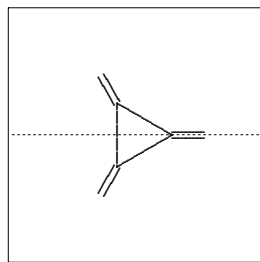

ER

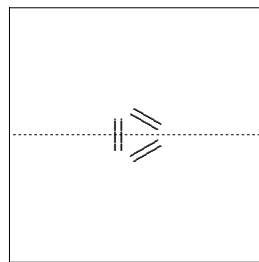

DB

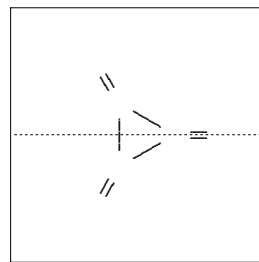

DR

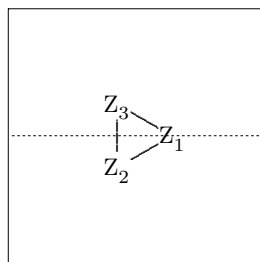

Z

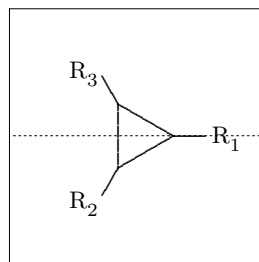

RZ

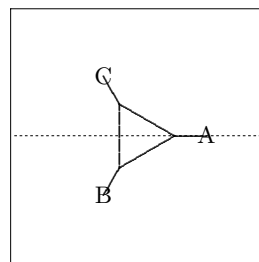

CRZ

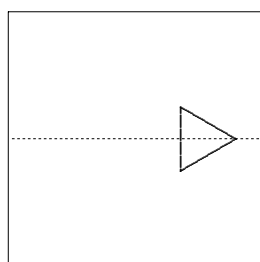

MOV1

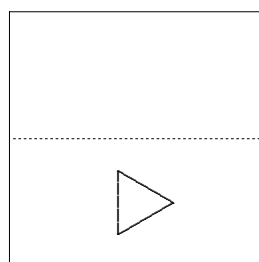

MOV2

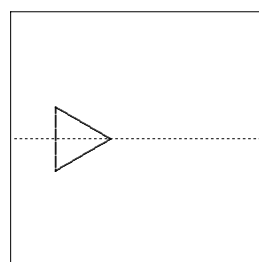

MOV3

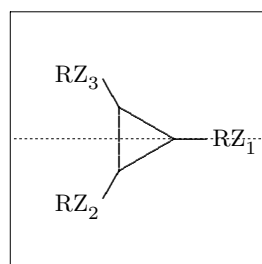

ROT1

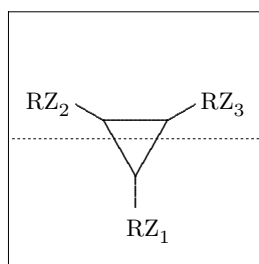

ROT2

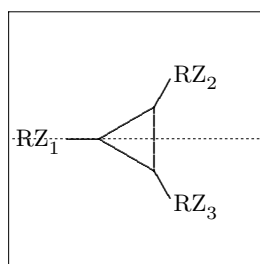

ROT3

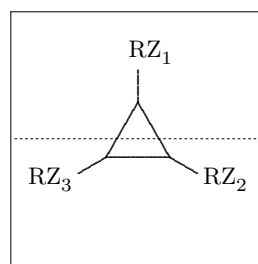

ROT4

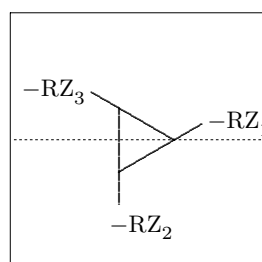

ROT1

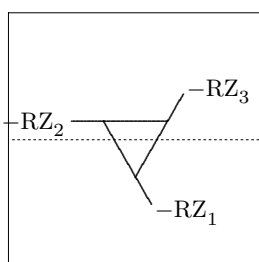

ROT2

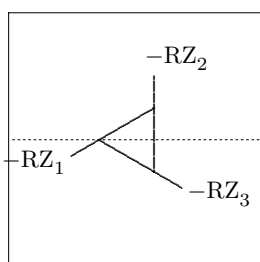

ROT3

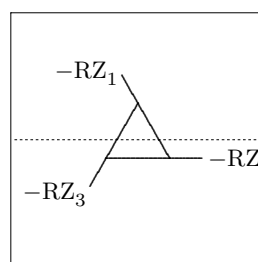

ROT4

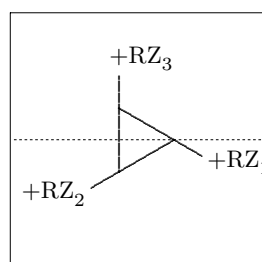

ROT1

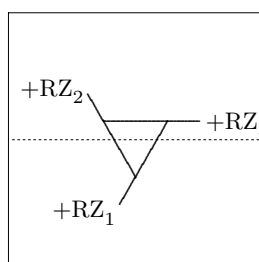

ROT2

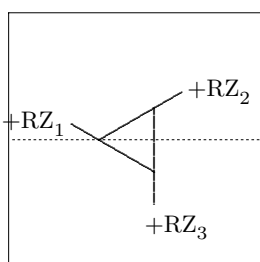

ROT3

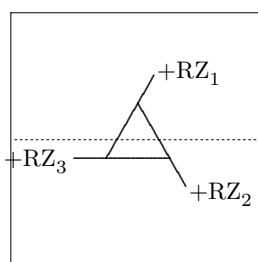

ROT4

# 3 | Four

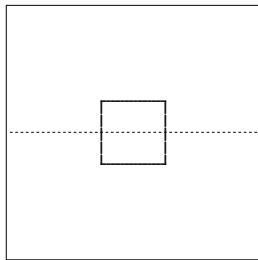

B

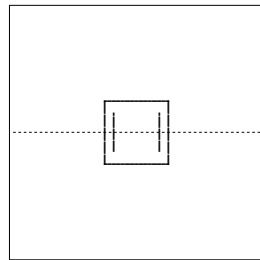

EB

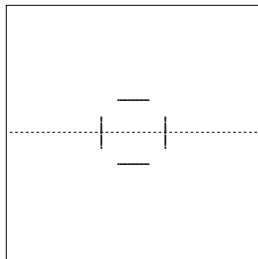

SB

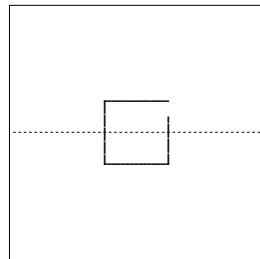

-SB

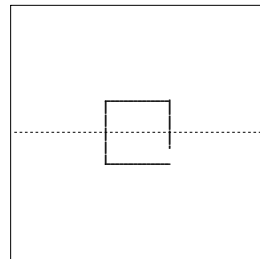

+SB

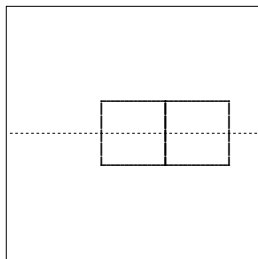

MOV

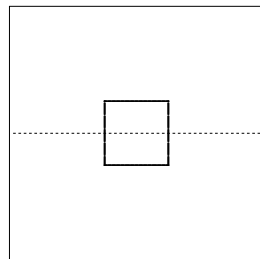

ROT

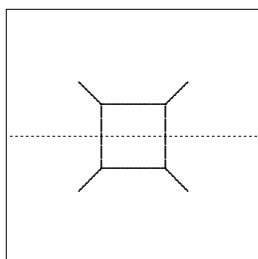

R

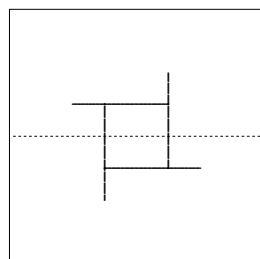

-R

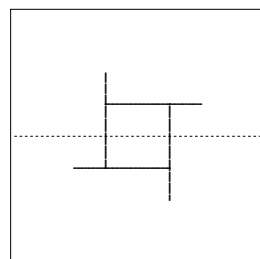

+R

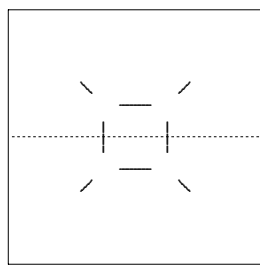

SR

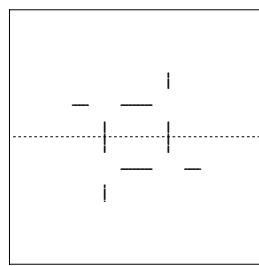

-SR

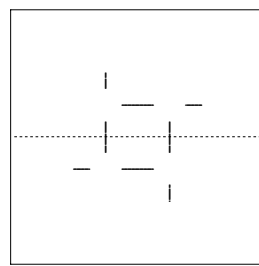

+SR

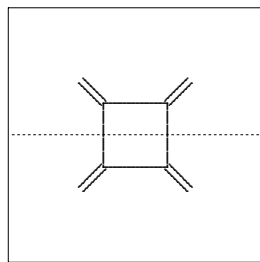

ER

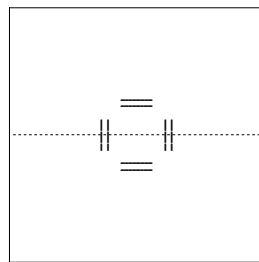

DB

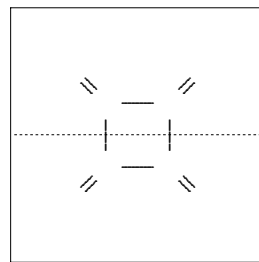

DR

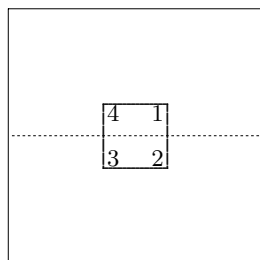

ZN

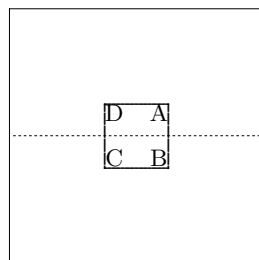

ZT

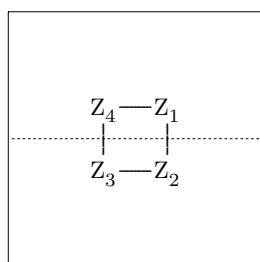

Z

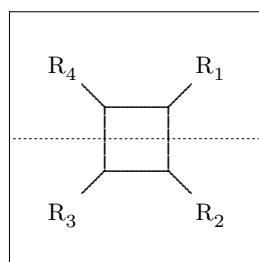

RZ

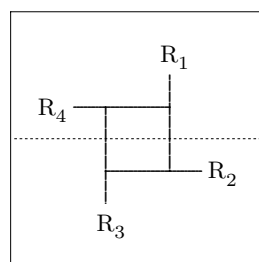

-RZ

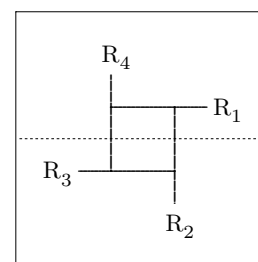

+RZ

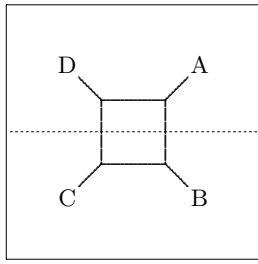

CRZ

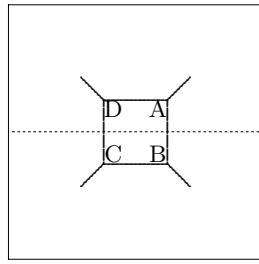

ZT

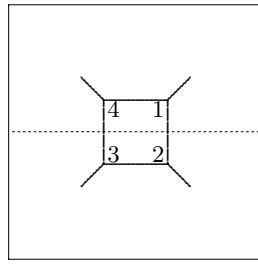

ZN

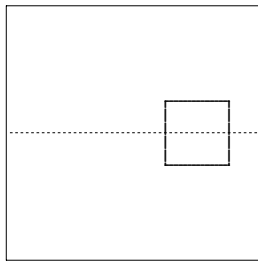

MOV1

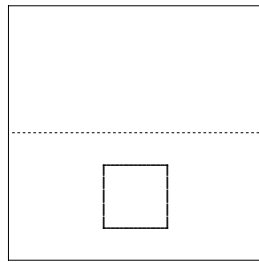

MOV2

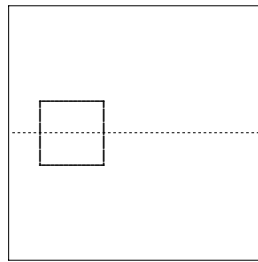

MOV3

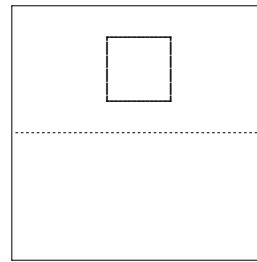

MOV4

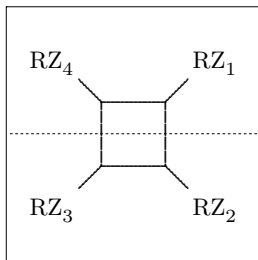

ROT1

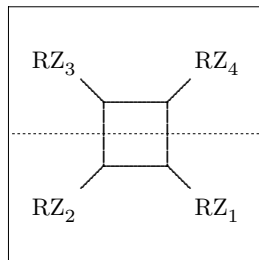

ROT2

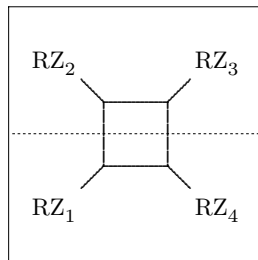

ROT3

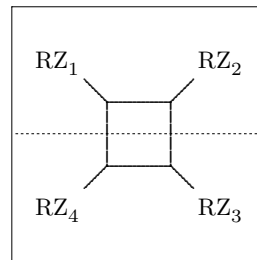

ROT4

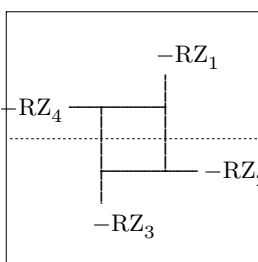

ROT1

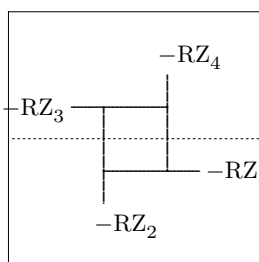

ROT2

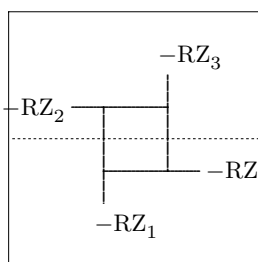

ROT3

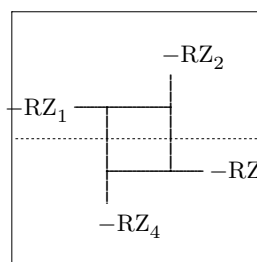

ROT4

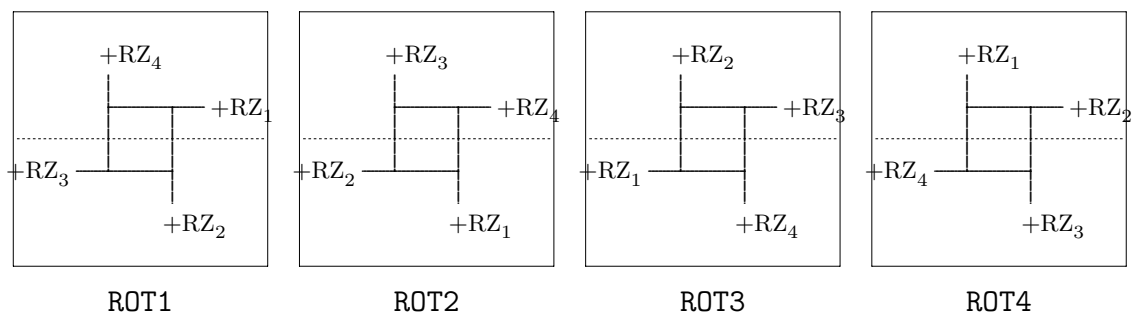

4 | Five

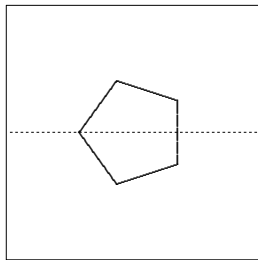

B

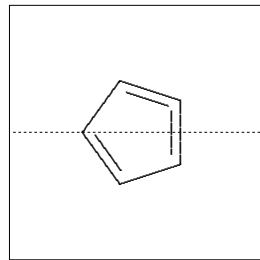

EB

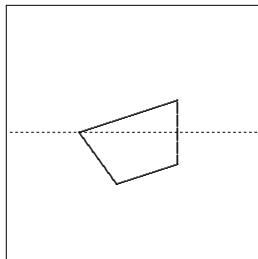

S

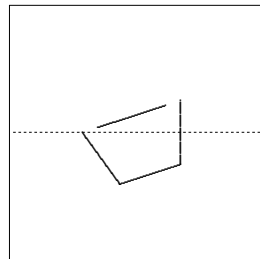

SS

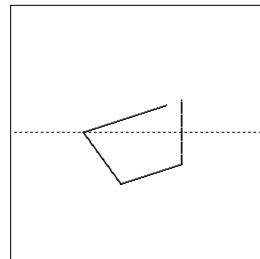

-SS

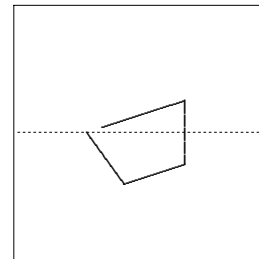

+SS

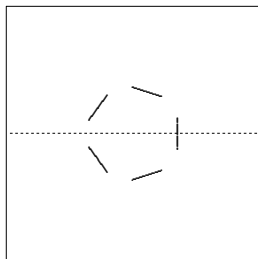

SB

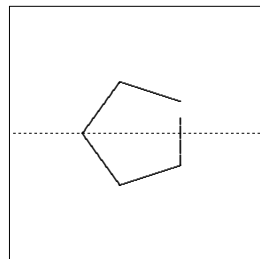

-SB

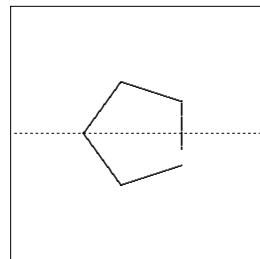

+SB

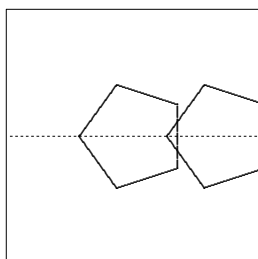

MOV

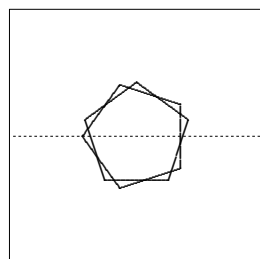

ROT



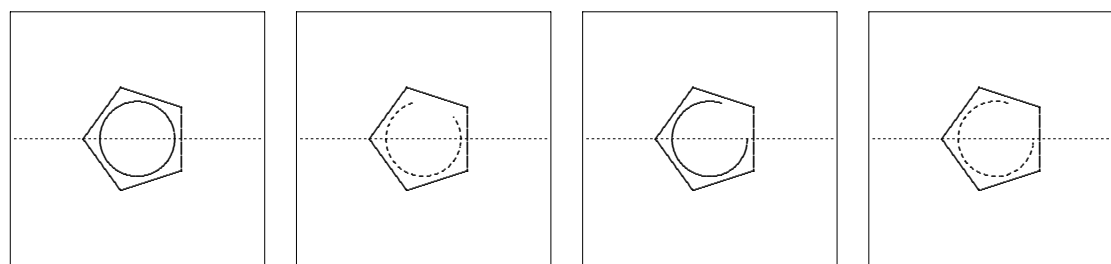

C

CD

CC

CCD

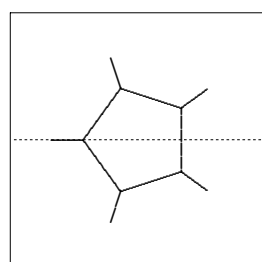

R

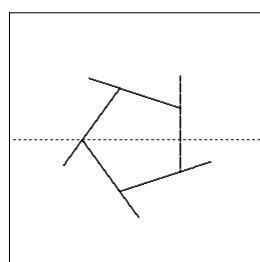

-R

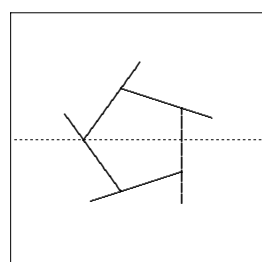

+R

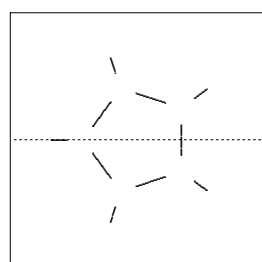

SR

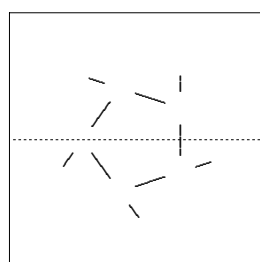

-SR

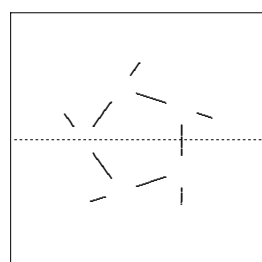

+SR

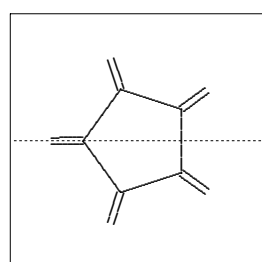

ER

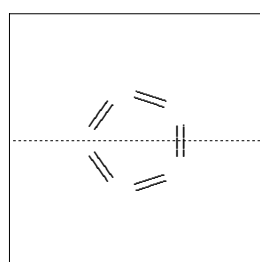

DB

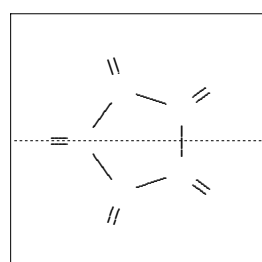

DR

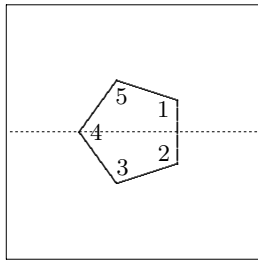

ZN

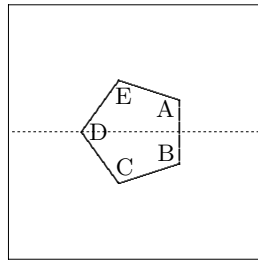

ZT

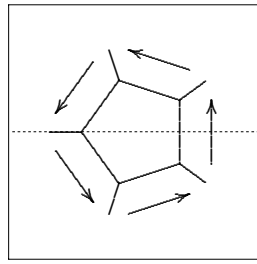

AU

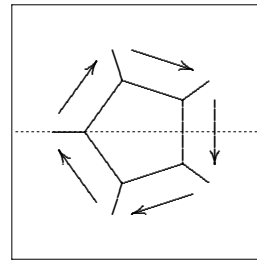

AD

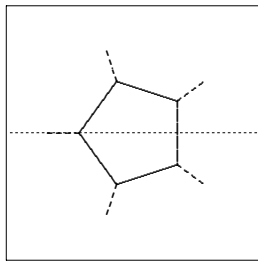

RD

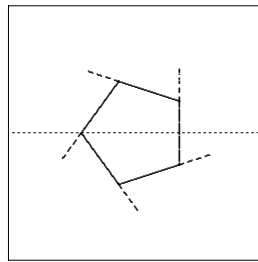

-RD

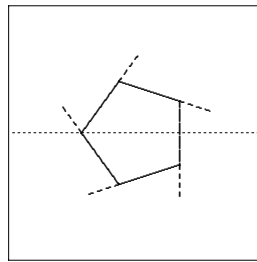

+RD

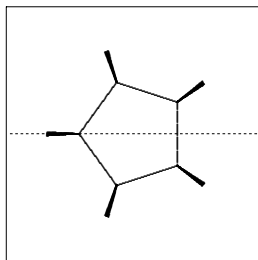

RB

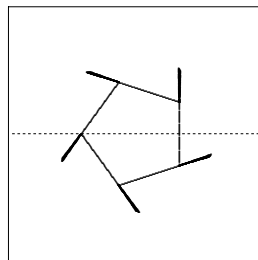

-RB

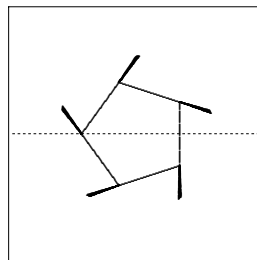

+RB

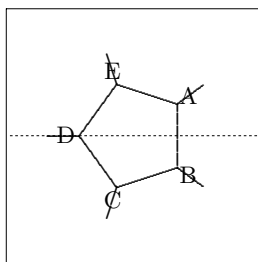

RT

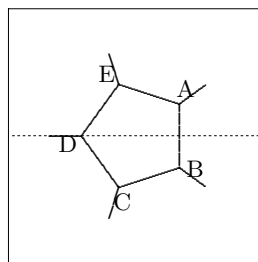

RTT

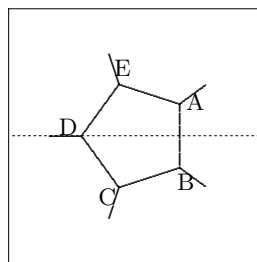

RBT

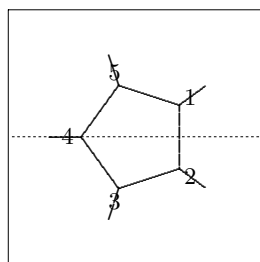

RN

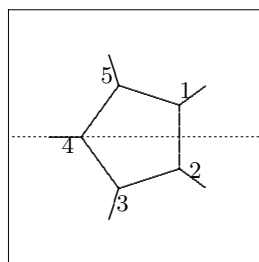

RTN

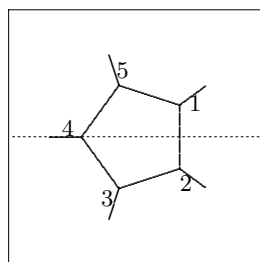

RBN

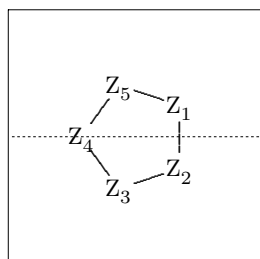

Z

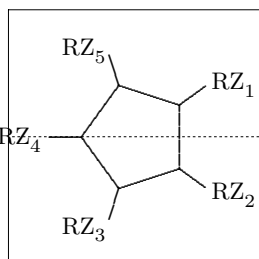

RZ

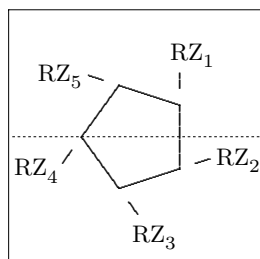

-RZ

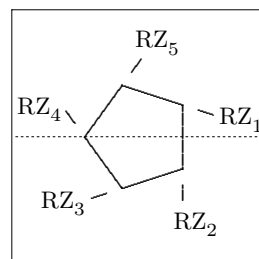

+RZ

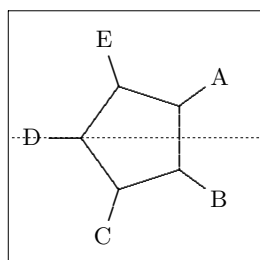

CRZ

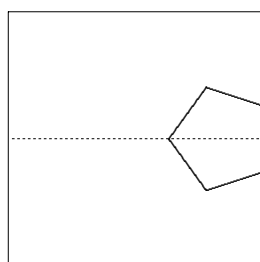

MOV1

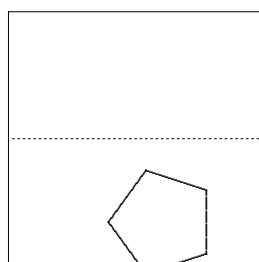

MOV2

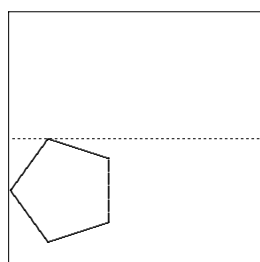

MOV3

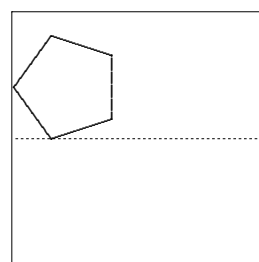

MOV4

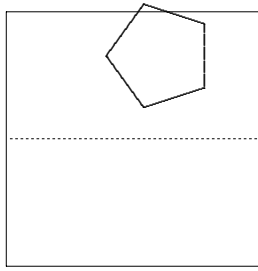

MOV5

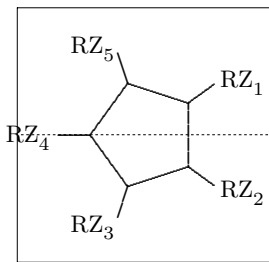

ROT1

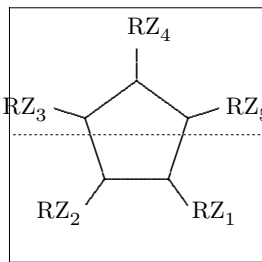

ROT2

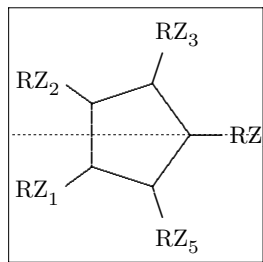

ROT3

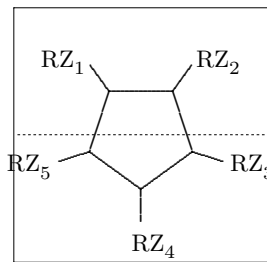

ROT4

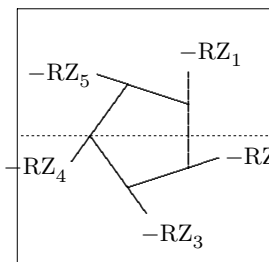

ROT1

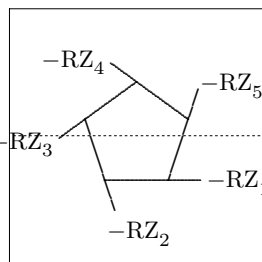

ROT2

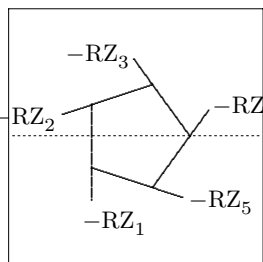

ROT3

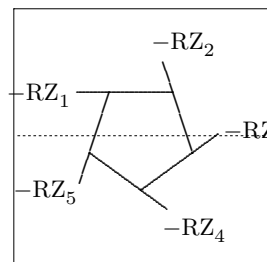

ROT4

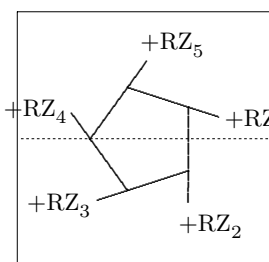

ROT1

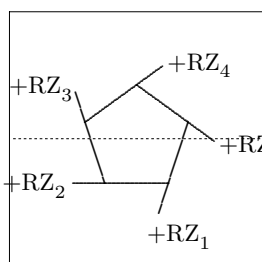

ROT2

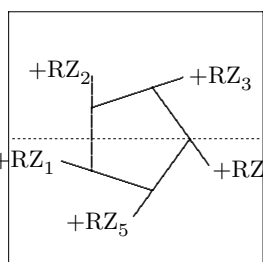

ROT3

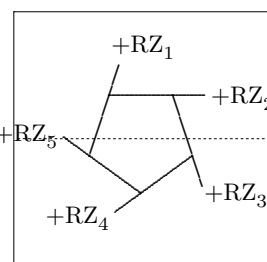

ROT4

5 | Six

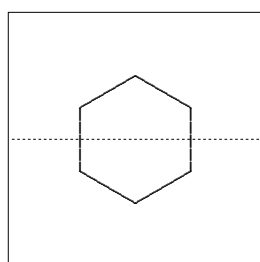

B

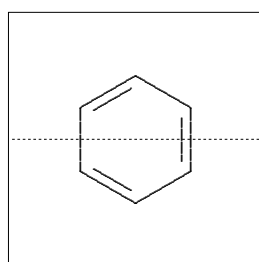

EB

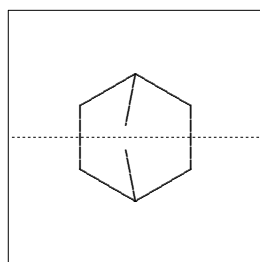

MID

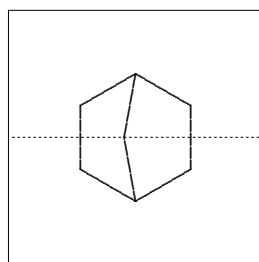

MIDS

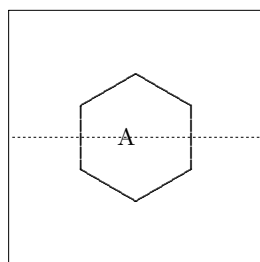

MIDZ

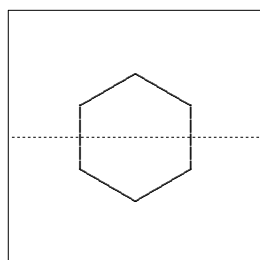

B

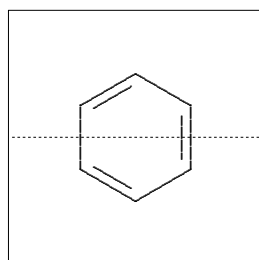

EB

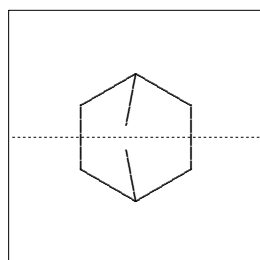

MID

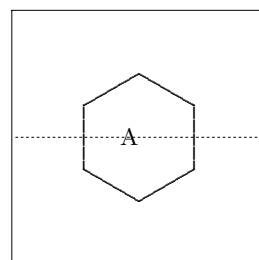

MIDZ

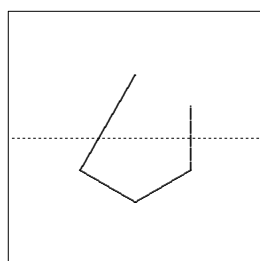

S

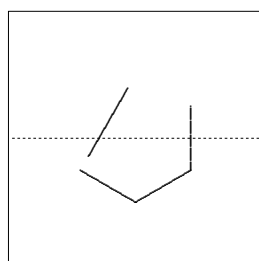

SS

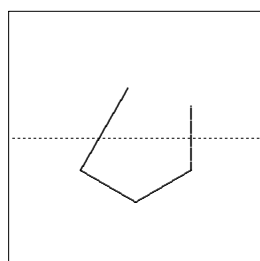

-SS

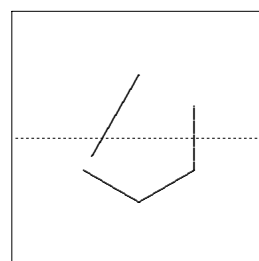

+SS

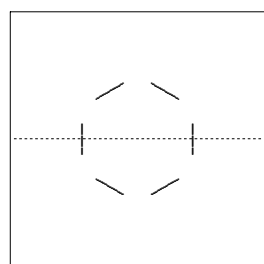

SB

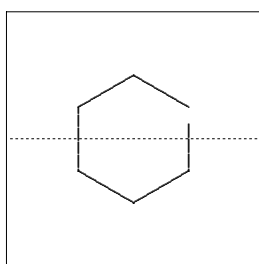

-SB

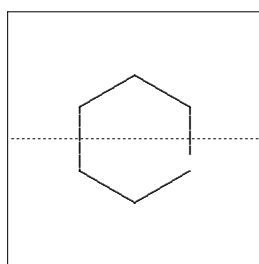

+SB

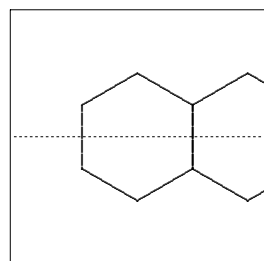

MOV

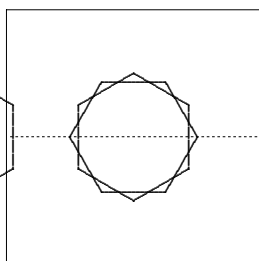

ROT

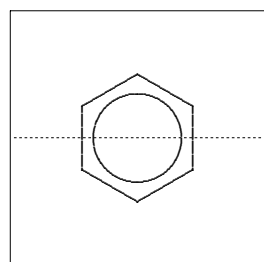

C

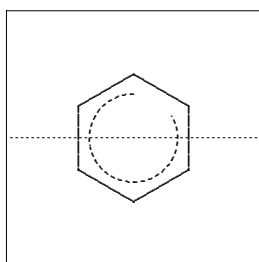

CD

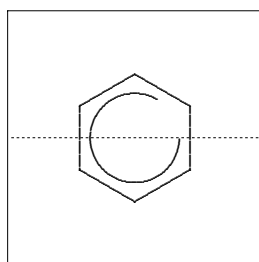

CC

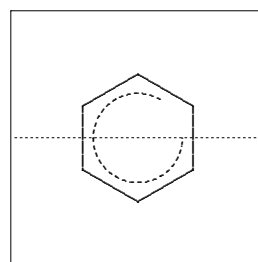

CCD

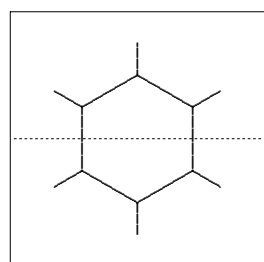

R

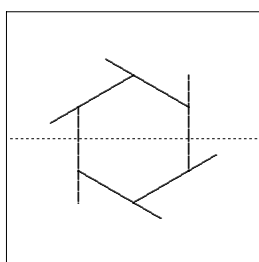

-R

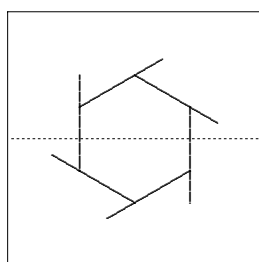

+R

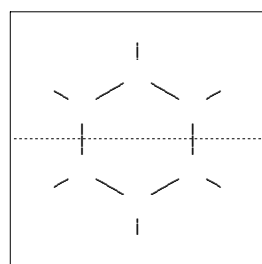

SR

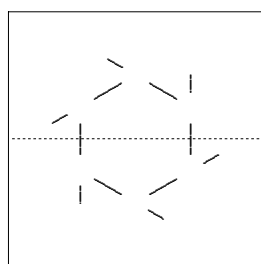

-SR

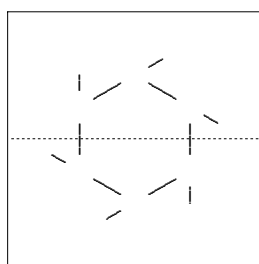

+SR

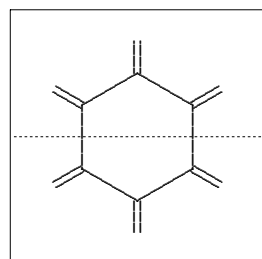

ER

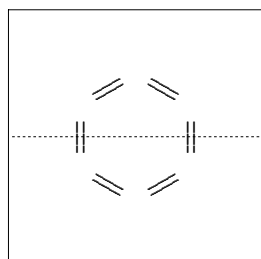

DB

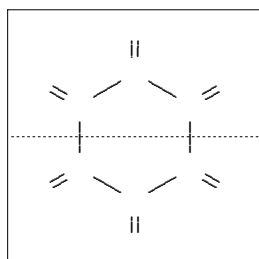

DR

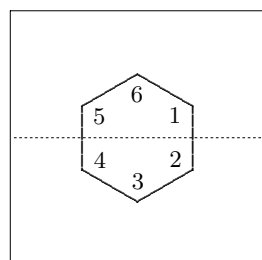

ZN

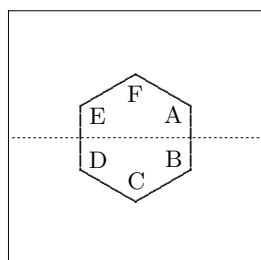

ZT

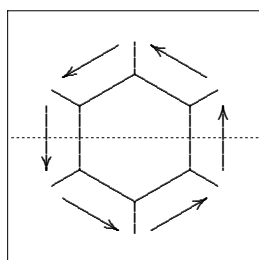

AU

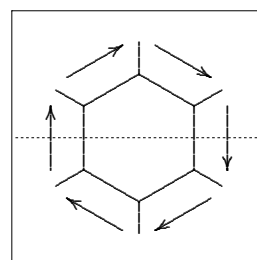

AD

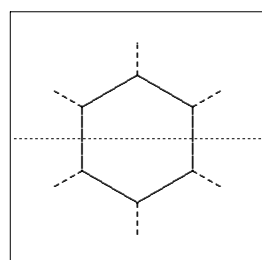

RD

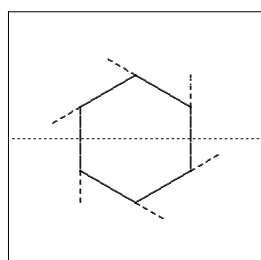

-RD

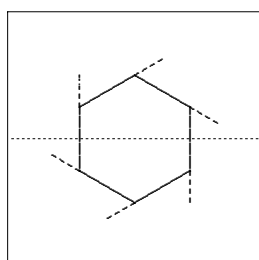

+RD

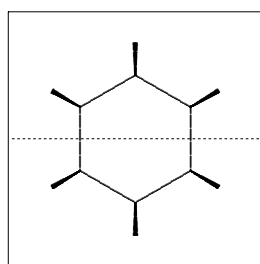

RB

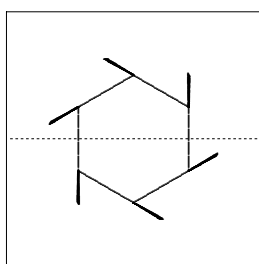

-RB

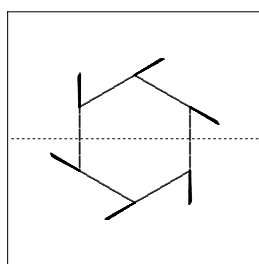

+RB

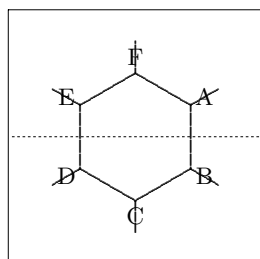

RT

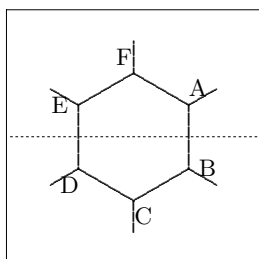

RTT

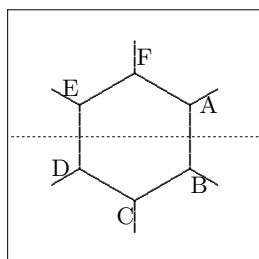

RBT

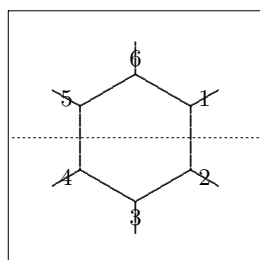

RN

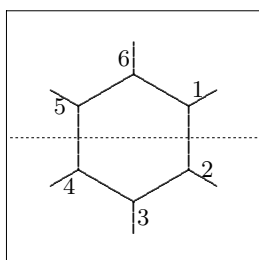

RTN

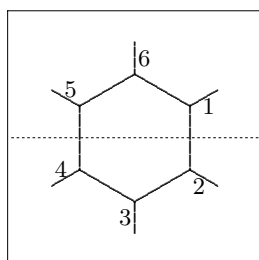

RBN

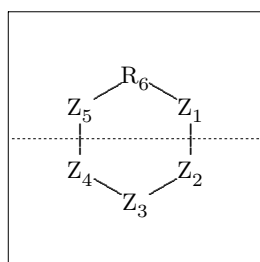

Z

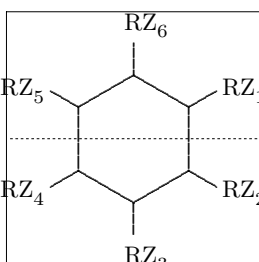

RZ

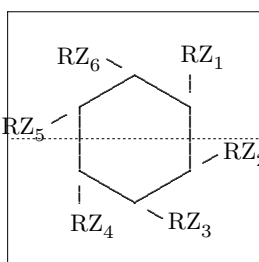

-RZ

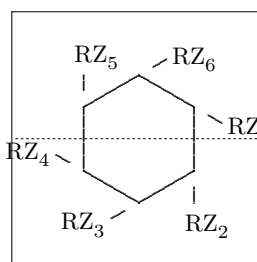

+RZ



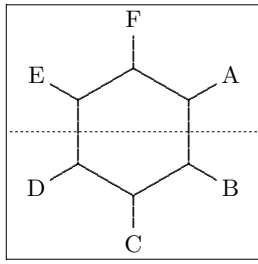

CRZ

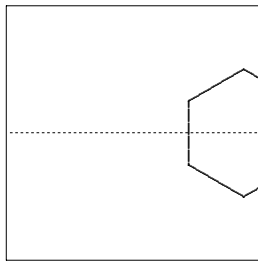

MOV1

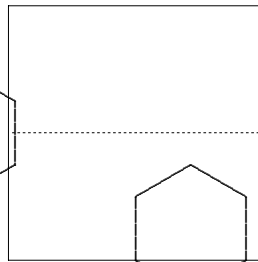

MOV2

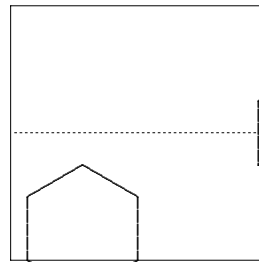

MOV3

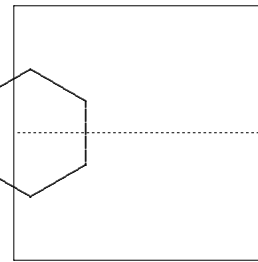

MOV4

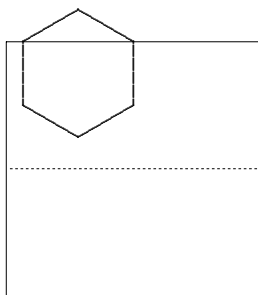

MOV5

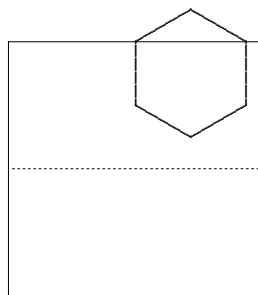

MOV6

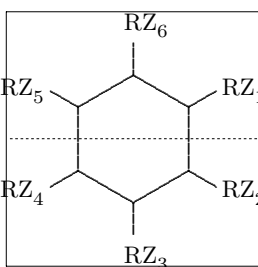

ROT1

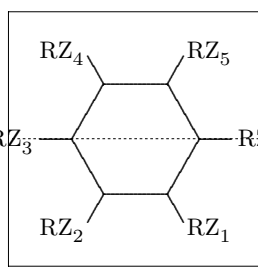

ROT2

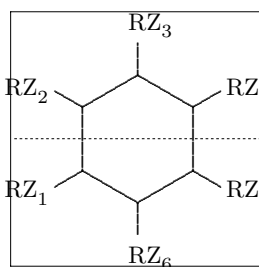

ROT3

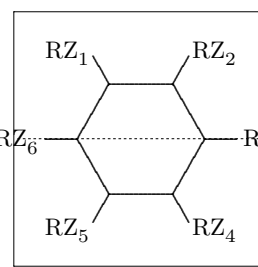

ROT4

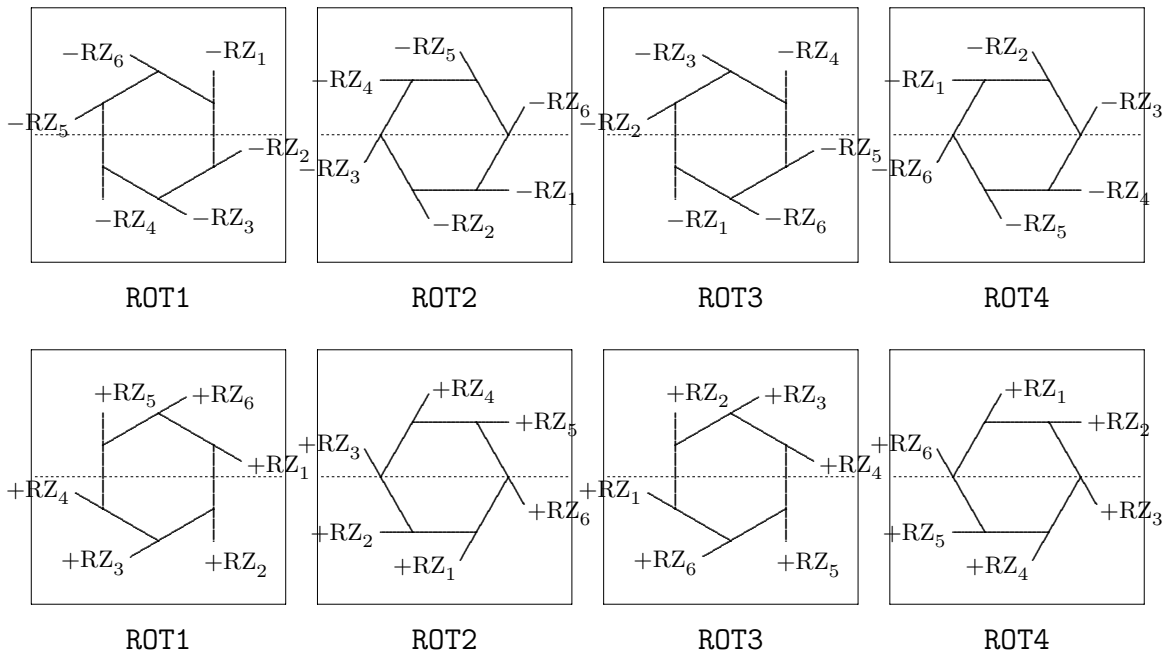

# 6 | Eight

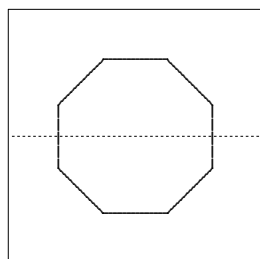

B

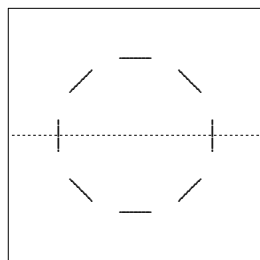

SB

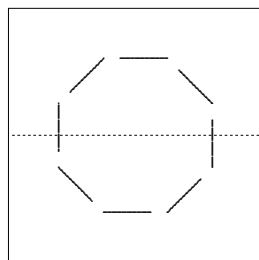

-SB

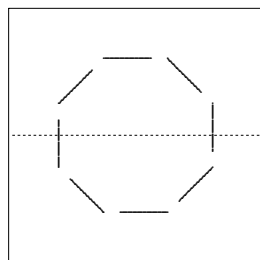

+SB

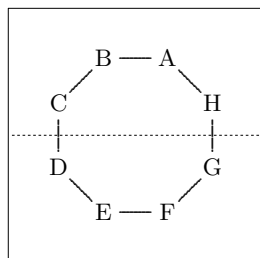

Z

# 7 | Five Front

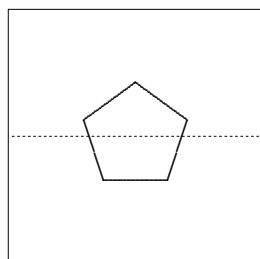

B

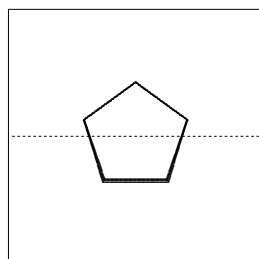

BB

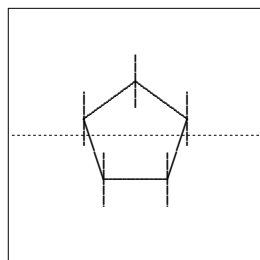

R

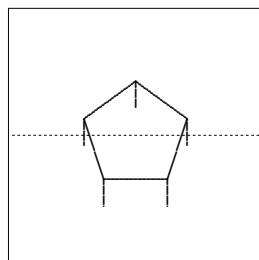

-R

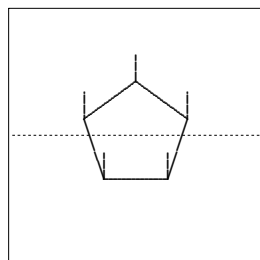

+R

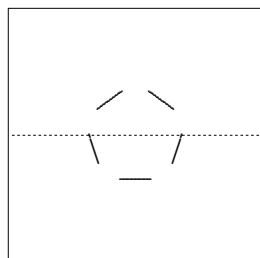

SB

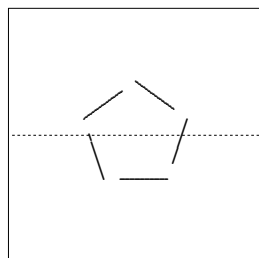

-SB

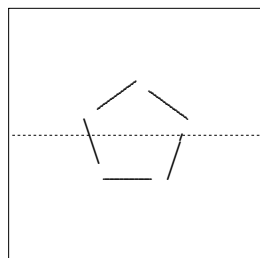

+SB

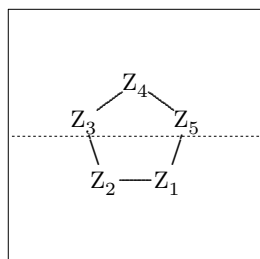

Z

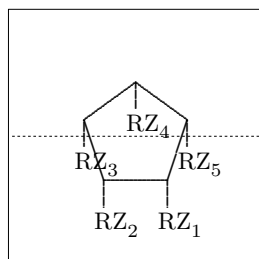

-RZ

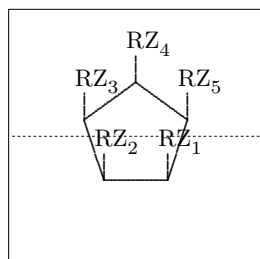

+RZ

# 8 | Six Front

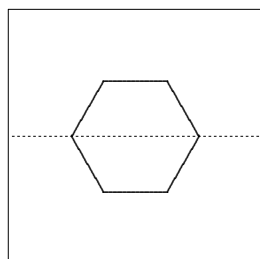

B

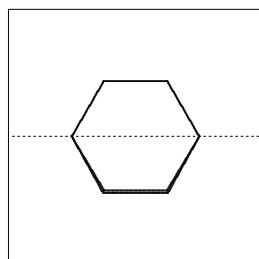

BB

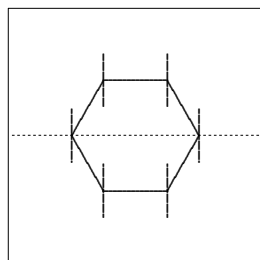

R

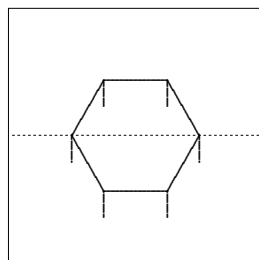

-R

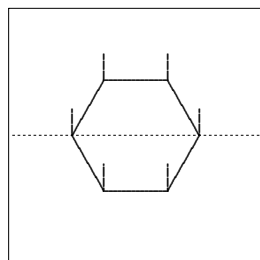

+R

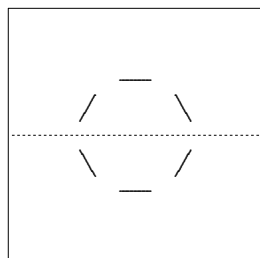

SB

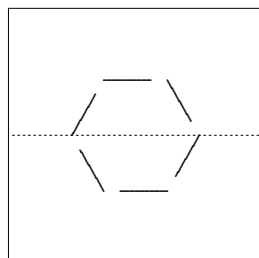

-SB

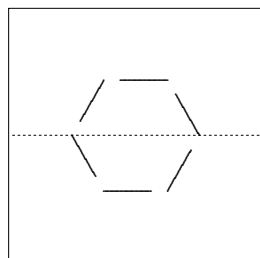

+SB

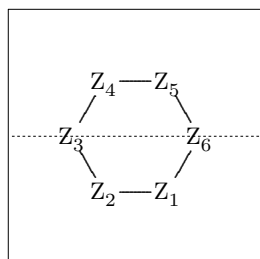

Z

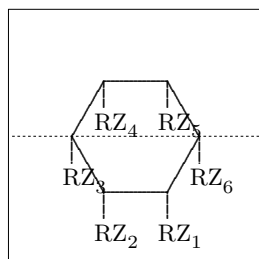

-RZ

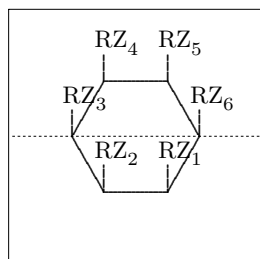

+RZ

# 9 | Carbon

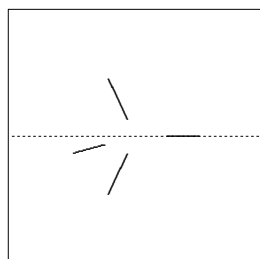

B

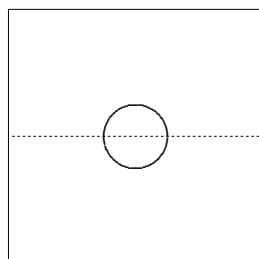

C

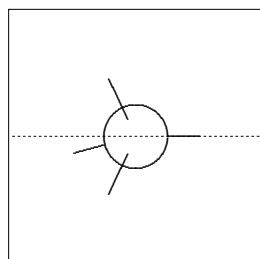

CB

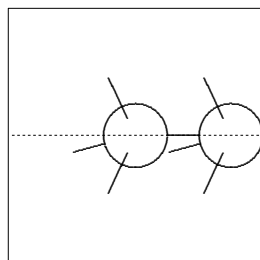

MOV

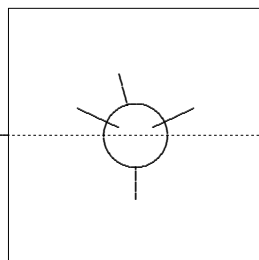

ROT

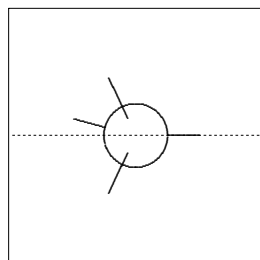

MIR

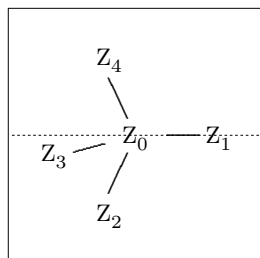

Z

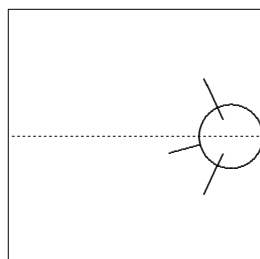

MOV1

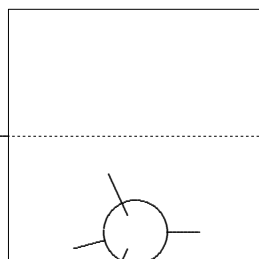

MOV2

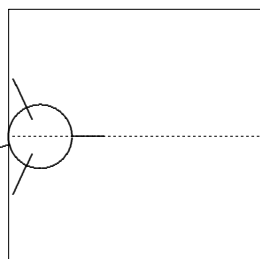

MOV3

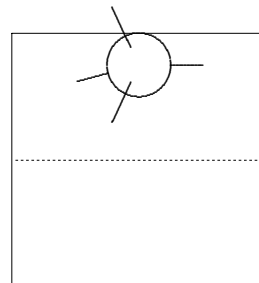

MOV4

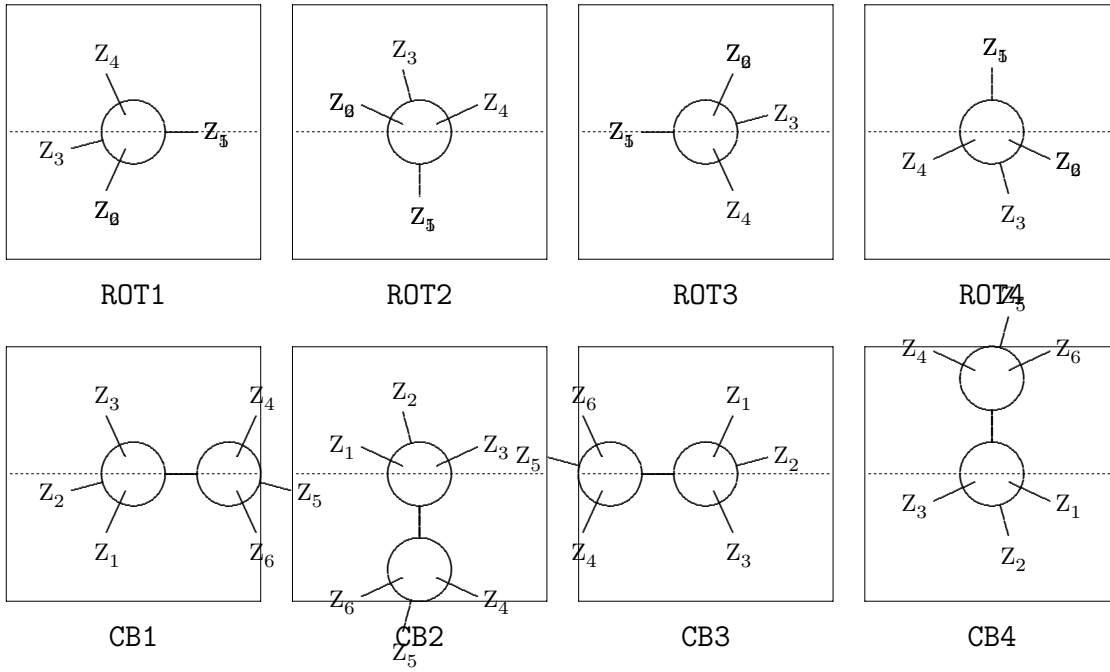

# 10 | Newman Stagger

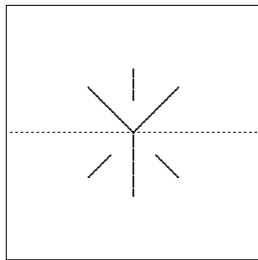

B

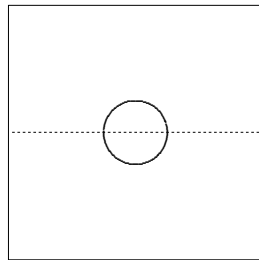

C

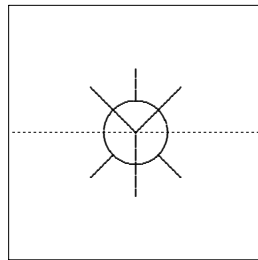

CB

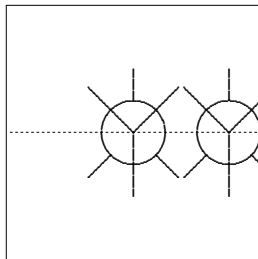

MOV

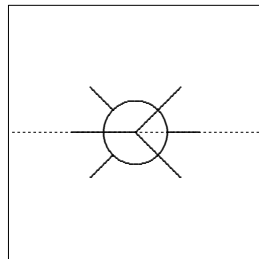

ROT

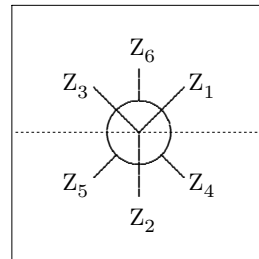

Z

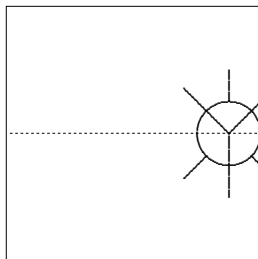

MOV1

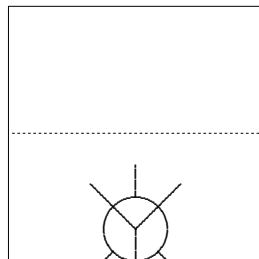

MOV2

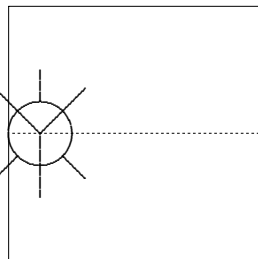

MOV3

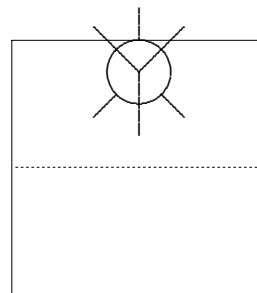

MOV4

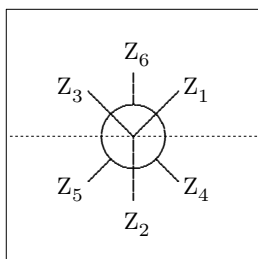

ROT1

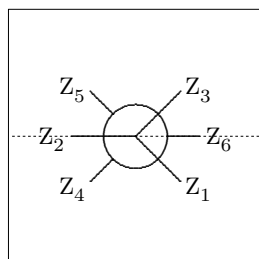

ROT2

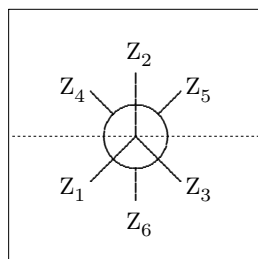

ROT3

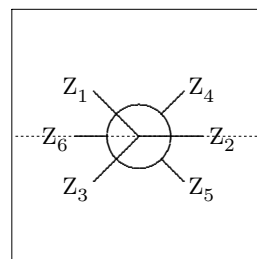

ROT4



# 11 | Newman Eclipse

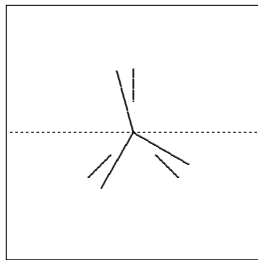

B

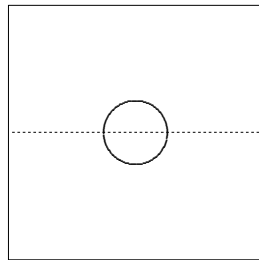

C

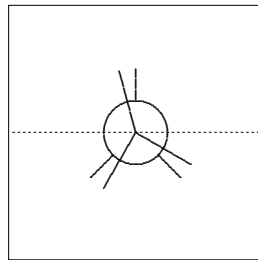

CB

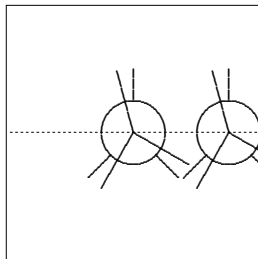

MOV

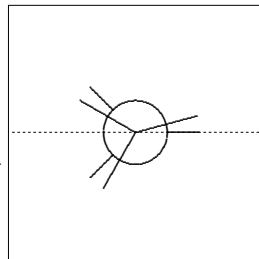

ROT

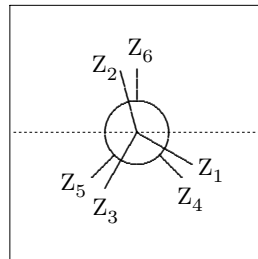

Z

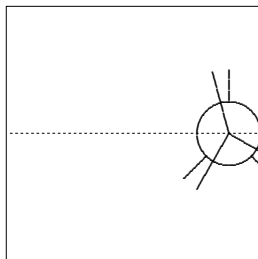

MOV1

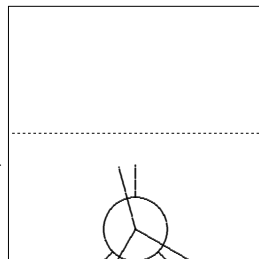

MOV2

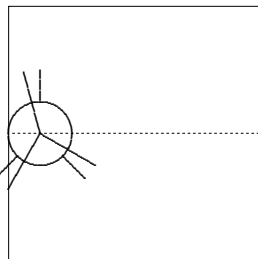

MOV3

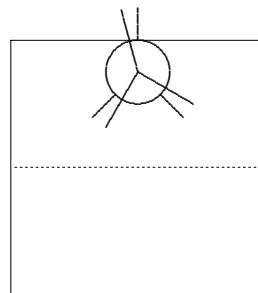

MOV4

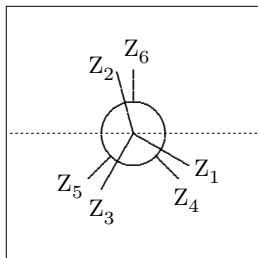

ROT1

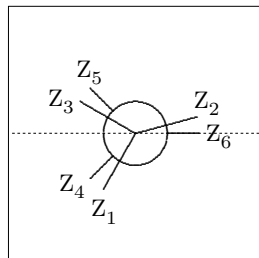

ROT2

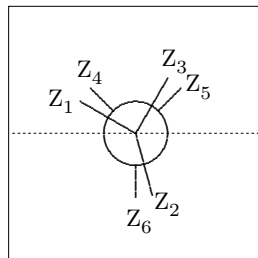

ROT3

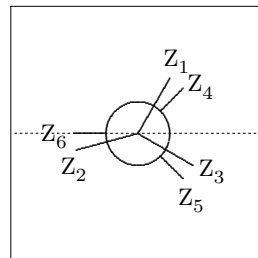

ROT4

# 12 | Symbol

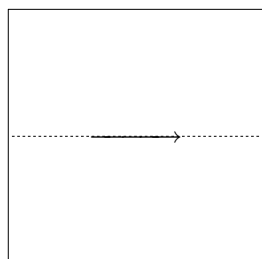

GIVES

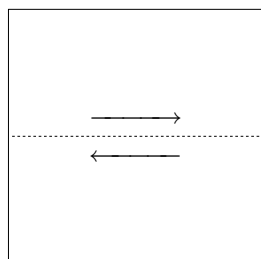

EQUILIBRIUM

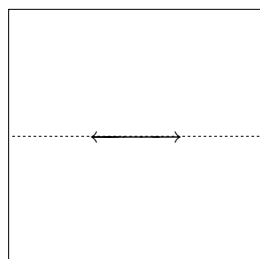

MESOMERIC

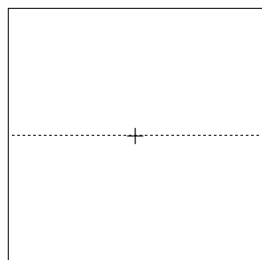

PLUS

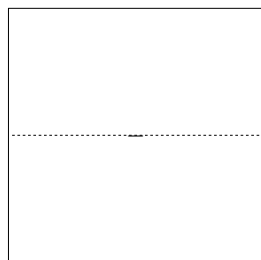

MINUS

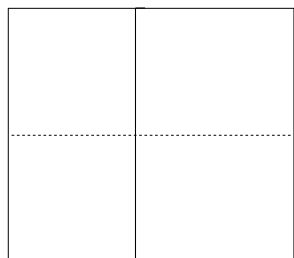

OPENCOMPLEX

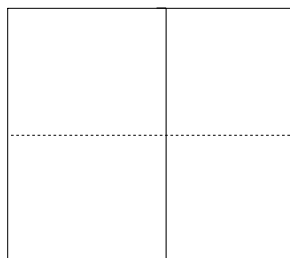

CLOSECOMPLEX

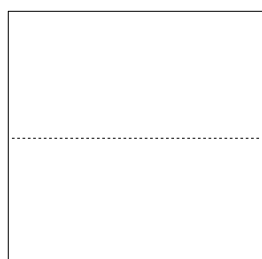

SPACE